

UVCS Version 2.0 and UVCS 39 User Guide

For Use with Fusion Flood Lamps

- Instructions for Safe Use
- Setup and Operation
- Maintenance
- Ordering Spare Parts and Accessories



About Dymax

UV/Visible light-curable adhesives. Systems for light curing, fluid dispensing, and fluid packaging.

Dymax manufactures industrial adhesives, light-curable adhesives, epoxy resins, cyanoacrylates, and activator-cured adhesives. We also manufacture a complete line of manual fluid dispensing systems, automatic fluid dispensing systems, and light-curing systems. Light-curing systems include LED light sources, spot, flood, and conveyor systems designed for compatibility and high performance with Dymax adhesives.

Dymax adhesives and light-curing systems optimize the speed of automated assembly, allow for 100% in-line inspection, and increase throughput. System designs enable stand-alone configuration or integration into your existing assembly line.

Please note that most dispensing and curing system applications are unique. Dymax does not warrant the fitness of the product for the intended application. Any warranty applicable to the product, its application, and use is strictly limited to that contained in the Dymax standard Conditions of Sale. Dymax recommends that any intended application be evaluated and tested by the user to ensure that desired performance criteria are satisfied. Dymax is willing to assist users in their performance testing and evaluation by offering equipment trial rental and leasing programs to assist in such testing and evaluations. Data sheets are available for valve controllers or pressure pots upon request.

Contents

Introduction	4
Introduction to the User Guide	4
Where to Get Help	4
Safety	4
General Safety Considerations	4
Specific Safety Considerations.....	5
Dymax UV Light-Curing System Safety Considerations	5
Product Overview	7
Description of the Dymax UVCS Conveyor System.....	7
Unpacking and Setup	7
Unpacking and Inspecting Your Shipment.....	7
Parts Included in the UVCS Conveyor.....	8
Lamp Installation and System Interconnect	8
Fusion Series Lamps	8
Conveyor Operation	12
Setting Adjustments	13
Adjusting Conveyor Blower Speed	13
Maintenance	14
Belt-Tracking Adjustment	14
Conveyor Belt Replacement	14
Troubleshooting	16
Spare Parts and Accessories	17
Fusion Lamp Spare/Replacement Parts.....	18
UVCS Conveyor Spare/ Replacement Parts	17
Conveyor Accessories	17
Specifications	18
Definition of Terms	21
Warranty	22
Index	23

Introduction

Introduction to the User Guide

This guide describes how to assemble, use, and maintain the Dymax UVCS Light-Curing Conveyor System safely and efficiently.

Intended Audience

Dymax prepared this user guide for experienced process engineers, technicians, and manufacturing personnel. If you are new to UV light curing and do not understand the instructions, contact Dymax Application Engineering to answer your questions before using the equipment.

Where to Get Help

Dymax Customer Support and Application Engineering teams are available in the United States, Monday through Friday, from 8:00 a.m. to 5:30 p.m. Eastern Standard Time. You can also email Dymax at info@dymax.com. Contact information for additional Dymax locations can be found on the back cover of this user guide.

Additional resources are available to ensure a trouble-free experience with our products:

- Detailed product information on www.dymax.com
- Dymax adhesive Product Data Sheets (PDS) on our website
- Material Safety Data Sheets (SDS) provided with shipments of Dymax adhesives.

Safety



WARNING! *If you use a Dymax light-curing conveyor without first reading and understanding the information in this user guide, injury can result from exposure to high-intensity light. To reduce the risk of injury, read and ensure you understand the information in this user guide before assembling and operating a Dymax conveyor system.*

To use this system safely, it must be set up and operated in accordance with the instructions given by Dymax. Using the system in any other manner will impair the protection of the system. Dymax assumes no liability for any changes that may impair the protection of the system.

General Safety Considerations

All users of Dymax equipment should read and understand this user guide before assembling and using the equipment.

To learn about the safe handling and use of light-curable formulations, obtain and read the SDS for each product. Dymax includes an SDS with each adhesive sold. In addition, fluid product SDS can be requested through our website.

Specific Safety Considerations

Dymax light-curing conveyors are designed to maximize operator safety and minimize exposure to UV light. To use the conveyor safely, it must be set up and operated in accordance with the instructions in this user guide.

Dymax UV Light-Curing System Safety Considerations

Dymax UV light-curing technology has been used successfully for over 30 years. The fast cure, one-component nature of our UV light-curing technology has made it the process of choice for many manufacturers requiring a "cure on demand" assembly process. Operators must understand these four concepts to use the UV light source safely: UV exposure, high-temperature surfaces, ozone, and bright, visible light. Each is described below.

UV Exposure

Standard Dymax UV light-curing systems have been designed primarily to emit UVA energy (Figure 1). UVA energy is generally considered the safest of the three UV ranges: UVA, UVB, and UVC. Although OSHA does not currently regulate UV light exposure in the workplace, the American Conference of Governmental Industrial Hygienists (ACGIH) does recommend Threshold Limit Values (TLVs) for ultraviolet light.

The strictest interpretation of the TLV (over the UVA range) for workers' eyes and skin allows continuous exposure up to 1 mW/cm^2 (intensity). Unless you are placing bare hands into the curing area, it is unusual to exceed these limits. To put 1 mW/cm^2 limit into perspective, a cloudless summer day will typically exceed 3 mW/cm^2 of UVA light, and also include the more dangerous UVB light (primarily responsible for sun tans, sun burns, and skin cancer) as well.

Figure 1. UV Spectrum

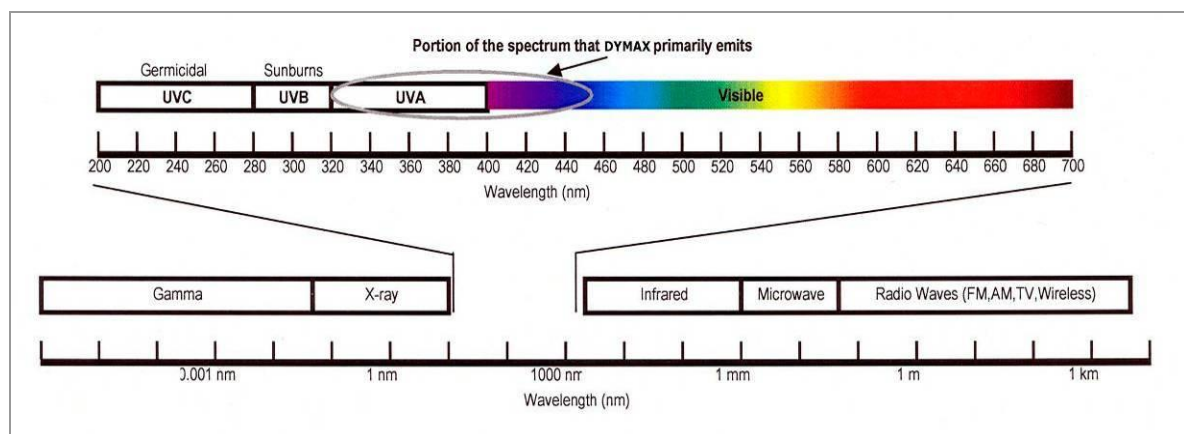

Checking the Workstation

The human eye cannot detect "pure" UV light, only visible light. A radiometer should be used to measure stray UV light to confirm the safety of a UV light-curing process. A workstation that exposes an operator to more than 1 mW/cm^2 of UVA continuously should be redesigned.

Protecting Operators

Light-curing technology can be a regulatory compliant, "worker-friendly" manufacturing process when the proper safety equipment and operator training is utilized. There are two ways to protect operators from UV exposure: shield the operator and/or shield the source.

Shield the Operator

UV-Blocking Eye Protection - UV-blocking eye protection is recommended when operating UV light-curing systems. Both clear and tinted UV-blocking eye protection is available from Dymax.

UV-Blocking Skin Protection — Where the potential exists for UV exposure upon skin, opaque, UV-blocking clothing, gloves, and full-face shields are recommended.

Shield the Source of UV

Any substrate that blocks UV light can be used as a shield to protect workers from stray UV light. The following materials can be used to create simple shielding structures or blind corners:

Sheet Metal — Sheet metal (aluminum, steel, stainless steel, etc) should be coated black or black anodized to minimize reflection of UV and visible light toward operators.

Rigid Plastic Film — Transparent or translucent/UV-blocking plastics (typically polycarbonate or acrylic) are commonly used to create shielding where some level of transparency is also desired. These rigid plastic films are available either water clear or tinted.

Flexible Film — UV-blocking, flexible urethane films can be used to quickly create workstation shielding. This UV-blocking, flexible urethane film is available from Dymax. Call for assistance.

High-Temperature Surfaces

Surfaces exposed to high-intensity curing lights may rise in temperature. The intensity, distance, exposure time, cooling fans, and composition of the surface can all affect the rise in surface temperature. In some cases, exposed surfaces can reach temperatures capable of producing a burn or causing damage to a substrate. In these cases, care must be taken to ensure either a more moderate surface temperature or appropriate protection/training for operators.

Ozone

Standard Dymax lamps (UVA type) generate an insignificant amount of UVC and therefore essentially no ozone. Some UV light-curing systems, like those used to cure UV inks, emit primarily “shortwave” (UVB and UVC) energy. Upon exposure to UVC light (specifically <240 nm), oxygen molecules (O₂) split into oxygen atoms (O) and recombine with O₂ to create ozone O₃. The current, long-term ozone concentration limit recommended by ACGIH, NIOSH, and OSHA is 0.1 ppm (0.2 mg/m³).

Bright, Visible Light

The bright, visible light energy emitted by UV light-curing systems can cause eye strain if proper eye protection or shielding is not used. The proper use of tinted eye protection and/or opaque/tinted shielding can be utilized to reduce eye strain and address this concern.

Summary

UV light sources can be more “worker friendly” than many commonly accepted industrial processes, provided the potential concerns are addressed. Contact your Dymax representative for information regarding the proper use of Dymax UV light-curing systems.

Product Overview

Description of the Dymax UVCS Conveyor System

The Dymax UVCS Light-Curing Conveyor System is designed to provide reliable and consistent processing of UV/Visible light-curable adhesives and coatings. Standard features include a Direct-Drive Motor, adjustable Lamp height, integrated and adjustable Cooling System, and a UV-Resistant Belt.

The UVCS is designed for bench- or table-top operations. The self-contained Cooling System and integral UV light allows the Conveyor to be placed virtually anywhere space permits.

Dymax UV light-curing sources are capable of curing a wide variety of light-curable adhesives, coatings, and inks. They have extensive use in a variety of applications such as bonding, potting, sealing, and encapsulating. These light sources offer exceptional versatility and expandability to accommodate most process demands.

A large number of accessories are available for the base Conveyor. These items address safety, as well as functional flexibility, which is depicted and discussed in this manual.

Figure 2. UVCS Conveyor System with Two Fusion Lamps

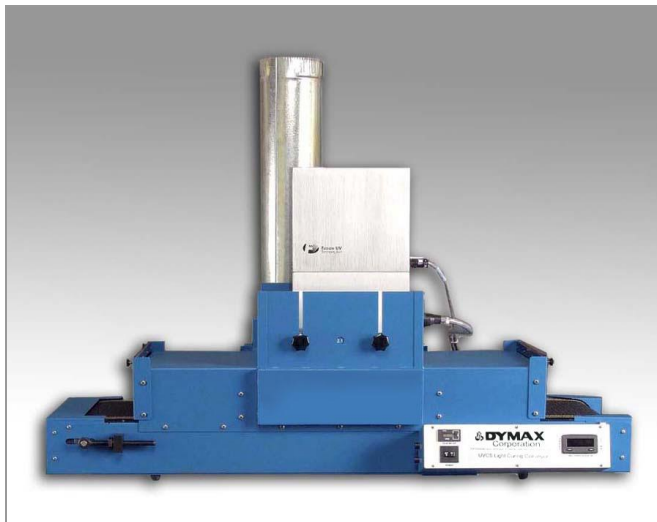

Unpacking and Setup

Unpacking and Inspecting Your Shipment

When your conveyor arrives, inspect any boxes for damage and notify the shipper immediately of box damage.

Open each box and check for equipment damage. If parts are damaged, notify the shipper and submit a claim for the damaged parts. Contact Dymax so that new parts can be shipped to you immediately.

Check that the parts included in your order match those listed below. If parts are missing, contact your local Dymax representative or Dymax Customer Support to resolve the problem.

Parts Included in the UVCS Conveyor

- **UVCS Conveyor Unit**
- **Lamp and Power Source Options** (Dependent on model number ordered) - A Lamp Power Supply that allows external electrical inputs and provides power to the Lamp located in the Reflector Assembly Housing. The Power Supply contains the On/Off Power Switch, Control, and Interlock Circuitry.

The Power Supply also houses its own Cooling Fans. The rear panel has an AC Power Receptacle, connections for the Lamp, Conveyor Interlocks, and Slave-Unit Control.

The Lamp Power Supply allows adjustment for different voltage and frequency conditions suitable for virtually any electrical system in the world. Switching between 50 and 60 HZ frequency operation requires movement of Capacitor Jumpers in the Power Supplies. See the Fusion Lamp Operators Manual included with your Conveyor System for specific instructions.

- **Power Cord**
- **Fusion “D” Bulb** (PN 36399) is standard. “H” Bulbs (PN 36441) and “V” Bulbs (PN 38146) are available upon request
- **UV Goggles**, Two Pairs
- **Dymax UVCS Conveyor System User Guide**

Lamp Installation and System Interconnect

Fusion Series Lamps

NOTE: Refer to the Fusion Lamp operator's manual for detailed Irradiator and Power Supply information.

1. If the optional Conveyor Cart (PN 39215) has been purchased, assemble the Conveyor Cart prior to building the Conveyor System.
2. Uncrate and assemble the Conveyor. See Dymax UVCS-Fusion Conveyor System Quick Start Instructions for Conveyor assembly instructions.
3. Install the Connector Cables from the Fusion Power Supply's J-105B and J-106 Connectors to the rear of the Conveyor (Figure 3).
4. Unpack the Fusion Lamp Assembly(ies). Each Lamp Assembly includes an Irradiator (Lamp), and Lamp-Connector Cord (Figure 4). For Dual-Fusion Lamp units, the Master Lamp Assembly includes an RF Detector, an RF-Detector Connector Cord, and “Master” to “Slave” Power-Supply Connector Cords.

CAUTION! Each Fusion Lamp Assembly has a fine mesh RF Screen covering the Lamp Face. Great care should be taken during installation and handling of these units to avoid puncturing or damaging the RF Screen. RF energy can be released if the RF Screen is damaged in any way.

Figure 3. Cable Configuration**Figure 4. Irradiator**

5. Inspect the RF Screen on the bottom of the Irradiator. Make sure there are no rips or tears in the RF Screen.

NOTE: Any tears in the RF Screen will result in an RF Interlock failure when the equipment is operated.

6. Mount the Irradiator(s) into the Conveyor's Lamp Support (Figure 5). Take particular care not to damage the Protective Screen covering the Bulb end of the Irradiators.

Figure 5. Conveyor with Lamp(s) Installed

7. Locate the RF Detector Mounting Bracket on the opening provided in the Lamp Basket Assembly (Figure 7). The RF Detector senses microwave leakage through the Rubber Window in the wall of the Conveyor. Microwave leakage indicates a torn Protective Screen on the bottom of the Irradiator.

NOTE: The RF Detector Assembly is pre-installed on all new conveyors purchased with Fusion Lamps.

8. Install the RF Detector next to the Fusion Irradiators on the Conveyor's intake side (if not already installed). Attach the RF Detector's Connector Cord to the RF Detector (Figure 7).

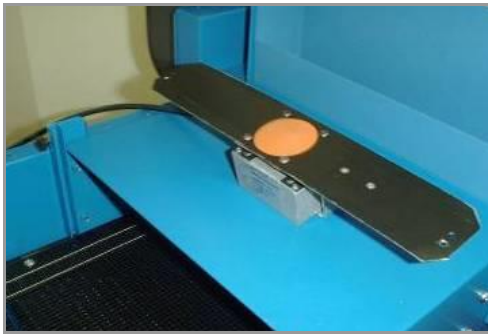
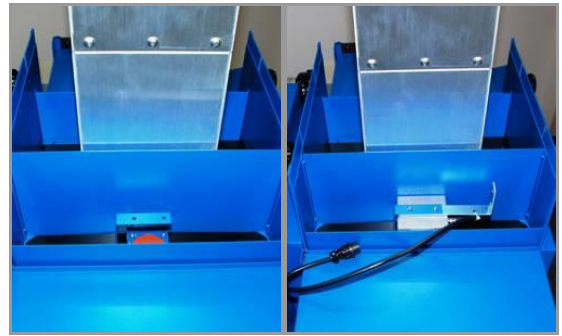
Figure 6. RF Detector Assembly**Figure 7. RF Detector Connector Cord**

9. Connect the Irradiator Cable(s) to the Irradiators (Figure 8).

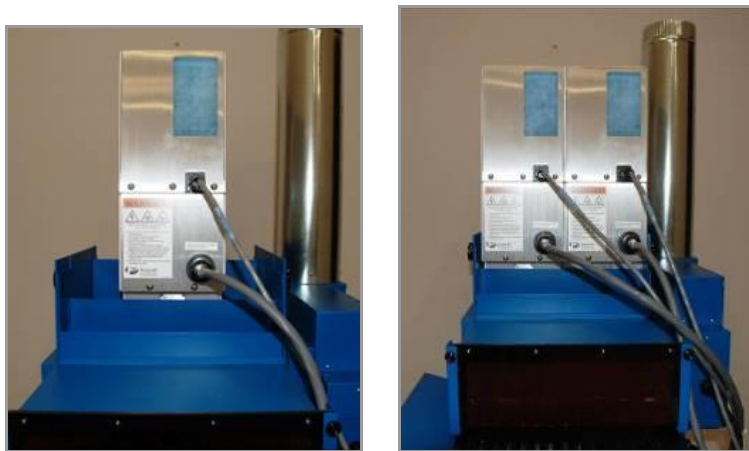
Figure 8. Irradiator Cable Connections

10. Unpack the Power Supply(ies). A 220-Volt Power Cord is provided with each Power Supply (Figure 9). The Power Supplies may be configured for either 50 or 60 HZ operation and for 208-, 220-, 230-, or 240-Volt operation. Changing between 50 and 60 HZ operation requires repositioning of two Capacitor Jumpers in each Power Supply. The Power Supply's shipping box is labeled with the voltage and frequency set at the factory. Detailed Power Supply setup instructions are provided in the Fusion Lamp operator's manual.

Figure 9. Power Supplies (front)

11. Position the Power Supply(ies) on the Conveyor's Mounting Stand or in a location near the Conveyor. Attach the Connector Cable leading from the RF Detector to the J-105A Receptacle on the back of the Master Power Supply. Attach the cables leading from the back of the Conveyor to

the J-105B and J-106 Receptacles of the Master Power Supply (Figure 10). These cables are labeled to aid in assembly.

Figure 10. Power Supplies (back)



12. For dual-Fusion units, connect the Jumper Cable between J-107 of the Master Power Supply and J-106 of the Slave Power Supply. Install the Jumper Plug in J-105A of the Slave Power Supply.
13. Connect the other end of the Irradiator Cable to the J-103 and J-104 Receptacles of the Power Supply(ies). Connect the Power Cord to the back of the Power Supply and to a 208-240-Volt Power Source.
14. Plug in the Conveyor and turn it on. When the Conveyor is operating, and the Belt is in motion, turn the Power Supply on by closing the Breakers on both of the Power Supply's Front Panels.
15. Turn the Irradiators on by pressing the Lamp On Button of the Master Power Supply (Figure 11). Both the Master and the Slave Power Supplies will go through a warm-up cycle. The Blower inside the Irradiators will turn on and the Lamps will ignite. The Lamps reach full intensity within 5 seconds after ignition. Your UVCS Conveyor is now ready for operation.

Figure 11. Power Supply (front)



Conveyor Operation

1. Install all safety accessories to protect operator from UV-light emissions.
2. Apply power to the Conveyor and turn it on.
3. Unlock the Speed Control Knob (Figure 13) and adjust the speed for the desired setting. The Speed Control Knob is a 10-Turn Potentiometer and allows speed adjustment from approximately 0.9 FPM to 32 FPM (feet per minute).

Figure 12. Conveyor Front Panel



Figure 13. Speed Control Knob



4. If any adjustments are needed for the Belt alignment, refer to the Maintenance Section of this manual.
5. Adjust the height of the Lamps to the desired distance.
6. Once all the settings (speed and Lamp height) have been properly set, the Conveyor is ready for operation.
7. When the Conveyor is operating and the Belt is in motion, turn the Power Supply on by closing the Breaker(s) on both of the Power Supply's Front Panels.
8. Turn the Irradiators on by pressing the Lamp On Button of the Master Power Supply (Figure 11). Both the Master and the Slave Power Supplies will go through a warm-up cycle. The Blower inside the Irradiators will turn on and the Lamps will ignite. The Lamps reach full intensity within 5 seconds after ignition. Your UVCS Conveyor is now ready for operation.

NOTE: The Fusion Power Supplies are interlocked with the Conveyor so that the Conveyor must be operating and the Conveyor Belt in motion before the Lamps will ignite. This prevents Belt overheating and damage that can result if the Belt is stationary when the Lamp is turned on.

Setting Adjustments

Adjusting Conveyor Blower Speed

The Blower controls the amount of cooling air provided to the Lamp Assemblies to keep them at proper operating temperatures. A small percentage of the cooling air is also diverted downward through the Conveyor Belt. This air flow provides a small hold-down force to keep light objects from moving while traveling on the belt. The Exhaust Blower speed is set at the factory during final system testing for the Conveyor model ordered.

If adjustment is required, remove the Access Panel from the front of the Exhaust Blower Housing (Figure 14), unlock the Speed Control Knob (Figure 15), adjust the Exhaust Blower speed setting, and relock the Speed Control Knob. The range of the Exhaust Blower Speed Control Knob is 0.0 to 0.85 turns. Table 1 shows the approximate settings for Exhaust Blower speed.

Figure 14. Access Panel



Figure 15. Speed Control Knob



Table 1. Blower-Speed Potentiometer and Lamp-Cradle Height Settings for Optimum Bulb Cooling

Model Number	Blower-Speed Potentiometer Setting		
	1 in	3 in	4.5 in
UVCS-F-1-230	0.20	0.40	0.54
UVCS-F-2-230	0.45	0.54	0.80

Maintenance

Belt-Tracking Adjustment

All Dymax UVCS Conveyors are factory adjusted to provide proper tracking of the Belt. Should further adjustments become necessary, this is done via two knurled Adjustment Knobs located at the input end of the Conveyor (Figure 16). To adjust tracking, simply tighten the side to which the Belt is tracking.

NOTE: Do not over tighten the Belt. This will lead to accelerated degradation of the Belt. The Belt should be stoppable with moderate hand pressure.

Figure 16. Belt-Tension Adjustment Knob

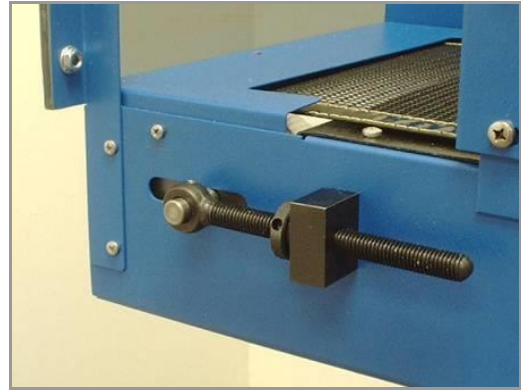

Conveyor Belt Replacement

1. Remove the Pinch Guard from the motor side of the Conveyor by removing the two M4x8 Screws (Figure 17) on the front side of the Conveyor and the M4x25 Screw (Figure 18) from the motor-drive side of the Conveyor.
2. Remove the Pinch Guard from the input side of the Conveyor by removing the three M4x8 Screws (Figure 19) from both sides.

Figure 17. Two M4x8 Screws



Figure 18. M4x25 Screw



Figure 19. Three M4x8 Screws

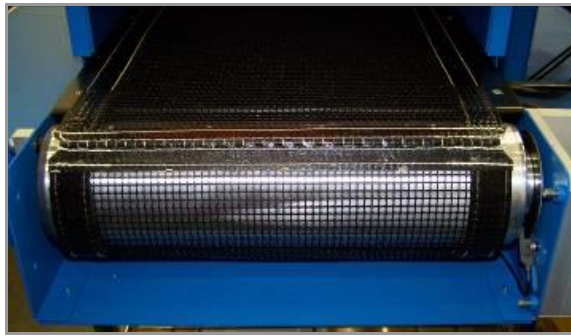
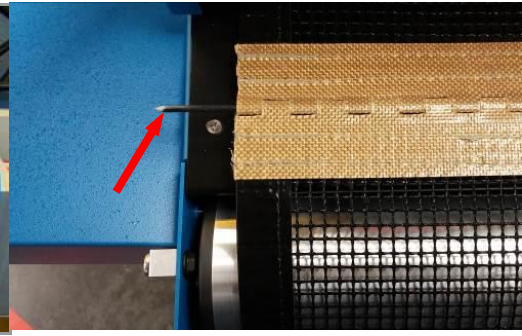
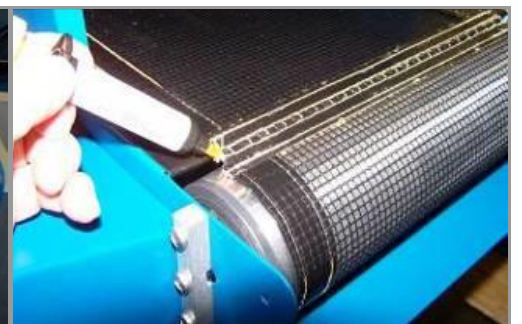

3. Remove all tension from the Belt by fully backing off the Belt-Tension Adjustment Knobs (Figure 16).
4. Position the Belt Splice to the end of the Conveyor (Figure 20). Remove the Fiberglass Rod that ties the ends of the Belt together (**Error! Reference source not found.**). Remove the Belt.
5. Run the new Belt around the Conveyor Frame (Figure 22).
6. Install the Fiberglass Rod through the Belt Loops.
7. Apply some adhesive to both ends of the Fiberglass Rod to prevent it from moving during Conveyor operation (Figure 23).

Figure 20. Spliced End of Belt**Figure 21. Fiberglass Rod****Figure 22. Replacing Belt****Figure 23. Applying Adhesive**

8. Equally tighten the Belt-Tension Knobs (Figure 16) on both sides of the conveyor to remove excess slack from the Belt. Enough tension should be applied on the Belt so that the Belt can only be moved across the two Rollers by moderate hand pressure when the Conveyor is not running.

CAUTION! Excessive tightening of the Belt will result in early Belt failure. Since the two Conveyor Rollers have a crown in the middle, only minimum tightening is necessary.

9. Start the Conveyor and adjust the Belt-Tensioning Knobs (Figure 16) until the Belt runs in the center of the loading end of the Conveyor. There should be enough tension on the Belt so that the Belt does not slip on the rollers, but loose enough so that it can be stopped by moderate hand pressure when the Conveyor is running. If stopping the Belt stalls the Conveyor Motor, the Belt is too tight and must be loosened.
10. Monitor the tracking of the Belt as the conveyor operates and use the Belt-Tensioning Knobs (Figure 16) to make fine adjustments. To adjust tracking, simply tighten the side to which the Belt is tracking.
11. Reinstall the Pinch Guards on both ends of the Conveyor. This step is critical to Belt-Speed Sensor operation. The Pinch Guard on the Unloading End of the Conveyor contains a Shield for the Sensor to prevent damage if the Belt contacts it while operating.
12. Verify that there is proper clearance between the Belt's seam and the Pinch Guard (Figure 24). If the Pinch Guard is too close to the Belt, contact Dymax for a replacement Pinch Guard.

Figure 24. Verify Pinch Guard

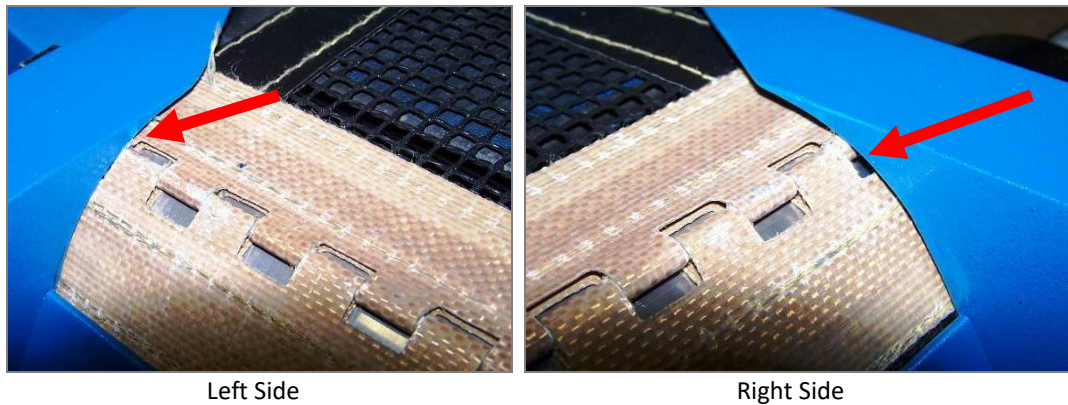

Troubleshooting

CAUTION! Only qualified maintenance personnel should attempt the following procedures.

Table 2. Troubleshooting Chart for the UVCS Conveyor

Problem	Possible Cause	Testing	Corrective Action
Conveyor is not operating	Main-Line Circuit Breaker deployed	Toggle Power Switch off, then on, to reset the Circuit Breaker.	Check current rating of the Breaker and compare to Table 4.
	Improperly fastened connections	Check all connections.	Properly fasten Power Cord.
	Fuses for Motor Controller blown	Remove Fuses from Fuse Holders (located in the left side of Control Box of unit) and check with an Ohmmeter.	Replace if defective.
	Belt is hung up	Inspect the Belt for any signs of a mechanical bind.	Resolve bind and continue operation.
	Tension too low on Belt (Power Switch will light and Motor will turn but the Belt does not move)	Verify the operation of the Drive Shaft and Drive Rollers.	Use the Tracking Adjustment Knobs to increase the tension on the Belt. Both Knobs will have to be turned the same amount to not affect the alignment.
Belt tracks to one side	Belt-Adjustment Knobs are out of position	Visually inspect the Belt. Belt will track to one side.	Tighten the Adjustment Knob (the one located on the side to which the Belt is tracking towards) until Belt tracks straight. Only minor adjustments should be made at one time.
Fusion Lamp(s) not igniting	Please reference the Fusion Lamp operator's manual for troubleshooting assistance.		

Spare Parts and Accessories

UVCS Conveyor Spare/ Replacement Parts

Item	Part Number
Blower, 230 VAC,	40147
Circuit Breaker, 115 VAC	39128
Conveyor Speed Potentiometer	40006
Curtain Assembly (2 Required)	39207
DC Motor Controller Resistor	40178
DC Motor Controller	40179
DC Motor Speed Indicator Sensor	39136
Exhaust Blower Speed Potentiometer	40149
Gear Motor, 90 VDC	43391
Hour Meter	35981
Mesh Belt	39134
Mesh Belt, Fine	39772
Pinch Guard, Conveyor Discharge	39119
Pinch Guard, Conveyor Inlet	39118
Red Lion Counter Timer 50020	39132
Red Lion 12V Power Supply	39133
Solid Acrylic Shield (2 Required)	39205
Speed Controller Knob	40143

Conveyor Accessories

Item	Part Number
Conveyor Rolling Cart Kit	39215
Riser Kit, 2" (for 6" of Clearance)	39218
Riser Kit, 6" (for 10" of Clearance)	39200
Shield Extension Kit	39209
UVCS 39 Transfer Plate Kit	42566

Fusion Lamp Spare/Replacement Parts

Item	Part Number
D Bulb UV	36399
H Bulb	36441
V Bulb	38146
Fusion Lamp Filter Kit	36560
Fusion Irradiator Screen Kit	37010
Fusion Lamp/Power Supply	36402
Magnetron	38136

Specifications

Table 3. Physical Specifications

Property	Specification	
Model	UVC-F-1-230	UVCS-F-2-230 & UVCS39-F-2-230
Part Number	39150	39160 & 42203
Lamp Configurations*	1 Fusion F300 Series Lamp	2 Fusion F300 Series Lamps
Cure Width	6" [152 mm]	12" [305 mm]
Motor Drive	Direct	
Belt Speed	1.0 – 32.0 ft/min [0.3 – 9.7 m/min]	
Belt Speed Display	Red LED, 1 decimal place	
Lamp Focus Adjustment	2.1" - 4.5" [53.3 mm - 114 mm]	
Maximum Part Height	4.5" [114 mm]**	
Exhaust System	1 integral centrifugal blower	

* The UVCS Series Conveyor has a 12" belt width. A single Fusion Lamp will utilize the center 6" of the Belt, while the Dual-Fusion Lamp configuration could span the full 12" width.

** Larger part heights are achievable with the installation of optional Riser Kits.

Figure 25. UVCS Version 2.0 Dimensions**Figure 26. UVCS 39 Dimensions**

Figure 27. Naming Convention**Table 4. Electrical Specifications**

Property	Specification
Voltage Requirements	208 or 230 VAC, 50 or 60 HZ
AC Current Values (Start/Run Current)*	Total Conveyor 2.4A / 1.2A rms
	Fan 1.0A rms
	Motor Control 200 mA rms
Lamp/Power Supply Input Voltage	200-240 VAC Fusion Lamp systems
Fusion Lamp Current Values and AC Current Requirements for Conveyor	AC Current at 115VAC N/A
	AC Current at 230VAC 15A (Each Lamp), Max of 2 Lamps
Conveyor and Lamps Total Input Current	UVCS-F-1-230 16.2A
	UVCS-F-2-230 & UVCS39 31.2A

* Reading at 200-230 VAC 50/60 Hz

Definition of Terms

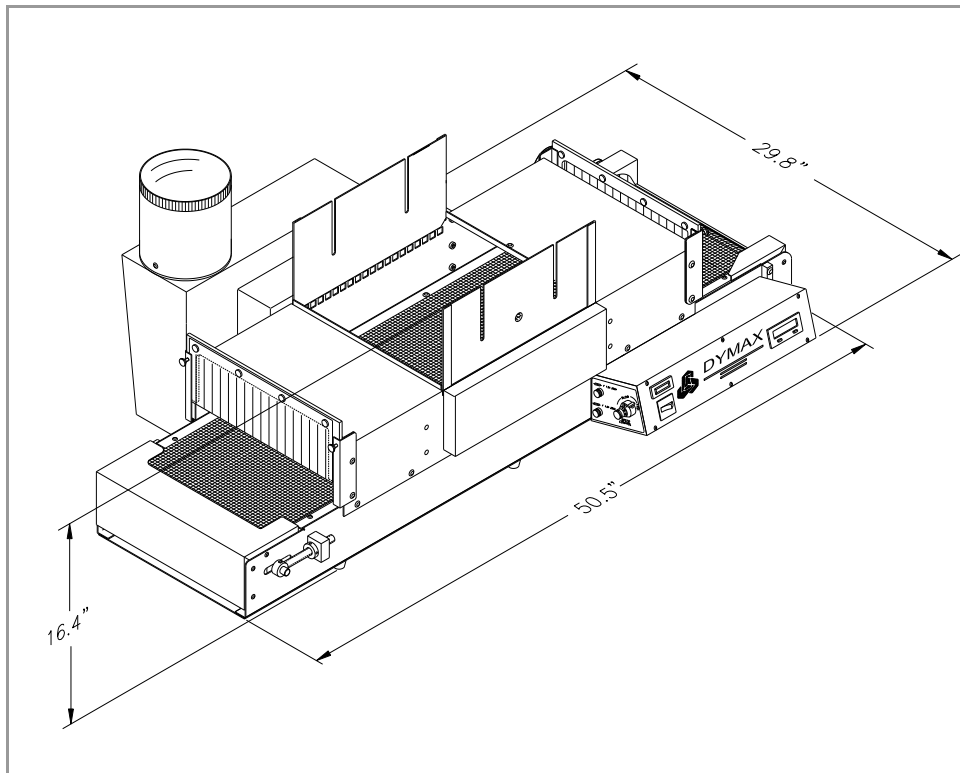
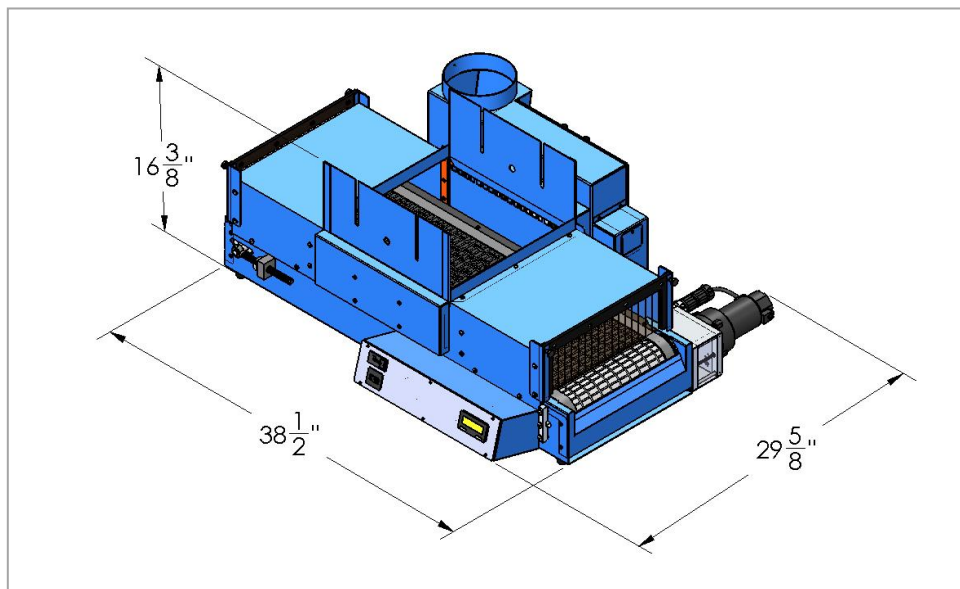
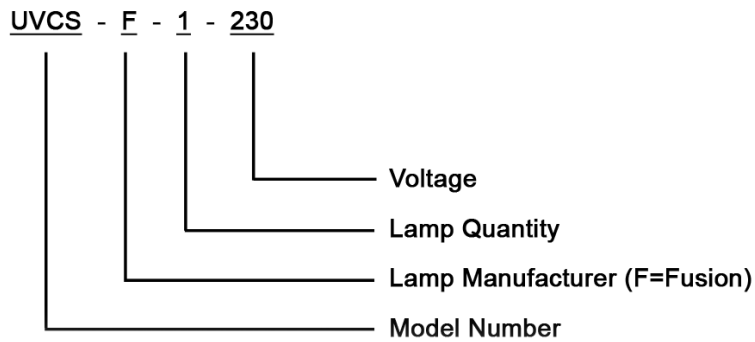
Brightness, also known as Luminance - description of energy in the visible region of the spectrum (approximately from 400 to 700 nm) and recorded in photometric units. “Intensity” (see below) of visible light energy is called Luminance.

Dose - is irradiance integrated over time, or Irradiance (W/cm^2) \times Time (s) = Dose ($\text{Joules}/\text{cm}^2$). Note: Watt is the power that gives rise to the production of energy at the rate of 1-joule (J) per second (s).

Intensity - a measure of light energy over the unit of surface area (usually surface at the specified working distance from the bottom of a reflector housing) in W/cm^2 or mW/cm^2 . For the UV portion of light, this measure is often called in literature “irradiance”, i.e. radiant energy arriving at a point on a surface per unit area.

Lamp - Light source generating Ultraviolet, Visible, and Infrared radiant energy from burning matter stimulated by electrical power conditioned by a proper power supply which is an integral part of a Lamp. A light source is usually placed into a reflector (of various geometry) to increase light source efficiency by collecting and directing radiant energy of selected spectra (for a given curing process).

Luminance - luminous flux (energy of visible light) incident per unit area, and measured in Lx (lux) or Lumen/ cm^2 .

Ozone - oxidizing agent (O_3) produced by the action of Ultraviolet radiant energy (below 185 nm) or electrical corona discharge of oxygen on air.

Ultraviolet (UV) - The invisible region of the spectrum just beyond the violet end of the visible region. Wavelength ranges in general from 1.0 to 400 nm. Dymax lamps (bulbs) do not radiate energy in deep Ultraviolet; there are very minute amounts below 220 nm and practically nothing can be sensed below 200 nm. This is due to the use of an ozone blocking quartz lamp envelope (See Ozone).

1. Ultraviolet A (UV-A) - UV of long wavelength from within approximately 400 to 320 nm of the spectral band (4000 to 3200 \oplus) - predominately produced by Dymax flood lamps.
2. Ultraviolet B (UV-B) - UV of medium wavelength from within approximately 320 to 280 nm - Dymax flood Lamps produce some amount of their energy within this bandwidth.
3. Ultraviolet C (UV-C) - UV of short wavelength below 280 nm (we say from 280 to 200 nm) – a large amount of this energy is present in the sunlight.
4. Visible – Light that can be seen 400-700 nm.

OSHA 1910.145: “Regulation of Accident prevention Signs and Tags” defines the following headers as:

- **WARNING** – is used when there is a hazardous situation that has some probability of severe injury.
- **CAUTION** - is used to indicate a hazardous situation that may result in minor or moderate injury.
- **NOTICE** - is used to convey a message related directly or indirectly to the safety of personnel, or protection of property.

Warranty

From date of purchase, Dymax Corporation offers a one-year warranty against defects in material and workmanship on all system components with proof of purchase and purchase date. Unauthorized repair, modification, or improper use of equipment may void your warranty benefits. The use of aftermarket replacement parts not supplied or approved by Dymax Corporation, will void any effective warranties and may result in damage to the equipment.

IMPORTANT NOTE: DYMAX CORPORATION RESERVES THE RIGHT TO INVALIDATE ANY WARRANTIES, EXPRESSED OR IMPLIED, DUE TO ANY REPAIRS PERFORMED OR ATTEMPTED ON DYMAX EQUIPMENT WITHOUT WRITTEN AUTHORIZATION FROM DYMAX. THOSE CORRECTIVE ACTIONS LISTED ABOVE ARE LIMITED TO THIS AUTHORIZATION.

Index

- Adjustments, 12
- Assembly and Setup, 7
- Belt Replacement, 14
- Belt Tracking Adjustment, 14
- Blower Speed, 12
- Contact Information, 4
- Curing System Safety, 5
- Definition of Terms, 21
- Dimensions, 19
- Electrical Specifications, 20
- Help, 4
- Installation, 8
- Maintenance, 14
- Operation, 12
- Optional Equipment, 17
- Parts List, 7
- Product Overview, 6
- Safety, 4
- Safety of UV Light
 - Bright, Visible Light, 6
 - High-Temperature Surfaces, 6
 - Ozone, 6
 - UV Exposure, 5
- Spare Parts and Accessories, 17
- Specifications, 19
- Support, 4
- System Interconnect, 8
- Troubleshooting, 17
- Unpacking, 7
- UV Exposure, 5
- UV Light Shielding, 6
- Warranty, 22



© 2019 Dymax Corporation. All rights reserved. All trademarks in this guide, except where noted, are the property of, or used under license by Dymax Corporation, U.S.A.

Please note that most dispensing and curing system applications are unique. Dymax does not warrant the fitness of the product for the intended application. Any warranty applicable to the product, its application and use is strictly limited to that contained in Dymax's standard Conditions of Sale. Dymax recommends that any intended application be evaluated and tested by the user to ensure that desired performance criteria are satisfied. Dymax is willing to assist users in their performance testing and evaluation by offering equipment trial rental and leasing programs to assist in such testing and evaluations. Data sheets are available for valve controllers or pressure pots upon request.

PN40480 MAN023DA 8/6/2019

Dymax Corporation

+1.860.482.1010 | info@dymax.com | www.dymax.com

Dymax Europe GmbH

+49 (0) 611.962.7900 | info_de@dymax.com | www.dymax.de

Dymax Engineering Adhesives Ireland Ltd.

+353 21.237.3016 | info_ie@dymax.com | www.dymax.ie

Dymax Oligomers & Coatings

+1.860.626.7006 | info_oc@dymax.com | www.dymax-oc.com

Dymax UV Adhesives & Equipment (Shanghai) Co. Ltd.

+86.21.37285759 | dymaxasia@dymax.com | www.dymax.com.cn

Dymax UV Adhesives & Equipment (Shenzhen) Co. Ltd.

+86.755.83485759 | dymaxasia@dymax.com | www.dymax.com.cn

Dymax Asia (H.K.) Limited

+852.2460.7038 | dymaxasia@dymax.com | www.dymax.com.cn

Dymax Asia Pacific Pte. Ltd.

+65.6752.2887 | info_ap@dymax.com | www.dymax-ap.com

Dymax Korea LLC

+82.2.784.3434 | info_kr@dymax.com | www.dymax.com/kr