

CE



BlueWave[®] MX-Series Multichannel Controllers

2- & 4-Channel Controllers for Use with
BlueWave[®] MX-Series Emitters
User Guide

 **DYMAX[®]**

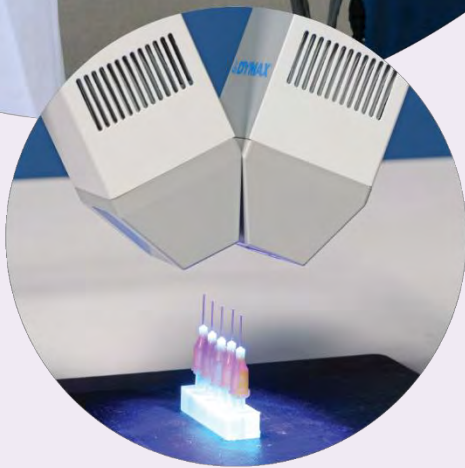

About Dymax

UV/Visible light-curable adhesives. Systems for light curing, fluid dispensing, and fluid packaging.

Dymax manufactures industrial, light-curable, epoxy, and activator-cured adhesives. We also manufacture a complete line of manual fluid dispensing systems, automatic fluid dispensing systems, and light-curing systems. Light-curing systems include LED light sources, spot, flood, and conveyor systems designed for compatibility and high performance with Dymax adhesives.

Dymax adhesives and light-curing systems optimize the speed of automated assembly, allow for in-line inspection, and increase throughput. System designs enable stand-alone configuration or integration into your existing assembly line.

Please note that most dispensing and curing system applications are unique. Dymax does not warrant the fitness of the product for the intended application. Any warranty applicable to the product, its application, and use is strictly limited to that contained in the Dymax standard Conditions of Sale. Dymax recommends that any intended application be evaluated and tested by the user to ensure that desired performance criteria are satisfied. Dymax is willing to assist users in their performance testing and evaluation by offering equipment trial rental and leasing programs to assist in such testing and evaluations. Data sheets are available for valve controllers or pressure pots upon request.

Contents

Introduction	4
Where to Get Help.....	4
Safety	4
General Safety Considerations	4
Safety Symbol Index	5
Specific Safety Considerations.....	5
Dymax UV Light-Curing General Safety Considerations.....	5
Product Overview	7
Description of BlueWave MX-Series Multichannel Controller ...	7
Features & Benefits	9
Control Panels.....	10
Unpacking.....	12
Unpacking and Inspecting Your Shipment.....	12
Parts Included	12
System Setup	12
System Connections	12
Modes of Operation	13
Manual Mode	13
Timed Mode	13
PLC (Programmable Logic Controller) Operation.....	14
Input/Output Interface.....	14
Examples of PLC Wiring	16
Examples of Master interlock / System Health Wiring	18
Operation	19
Admin Screen	19
Touch Screen Interface	19
Irradiation.....	22
Loading and Saving Programs.....	23
System Screens.....	23
System Information	23
Curing Time Screen	24
Power Level Screen	24
Cure Delay Screen	25
Production Screen	26
PLC Screen	26
Program Screen	27
Program Name Screen	27
Settings Screen	27
User Screen	28

New Password Screen.....	28
Troubleshooting & Maintenance.....	28
Product Cleaning.....	28
System Information	29
Alarms Screen	29
Troubleshooting.....	30
Alarm Codes: MX-4E.....	31
MX-4E Extension Module.....	31
Spare Parts & Accessories	32
Accessories	32
Components & Spare Parts	32
Specifications	34
Declaration of Conformity	35
Validation	37
Set Exposure Time, Determine Intensity	37
Set Intensity, Determine Exposure Time	37
Control	37
Warranty	38
Index.....	38

Introduction

This guide describes how to set up, use, and maintain BlueWave® MX-Series 2CH & 4CH Multichannel Controller safely and efficiently.

Intended Audience

This user guide is meant for experienced process engineers, technicians, and manufacturing personnel. If you are new to high-intensity LED light sources and do not understand the instructions, contact Dymax Application Engineering for answers to your questions before using the equipment.

Where to Get Help

Dymax Customer Support and Application Engineering teams are available by phone in the United States, Monday through Friday, from 8:00 a.m. to 5:30 p.m. Eastern Standard Time. You can also email Dymax at info@dymax.com. Contact information for additional Dymax locations can be found on the back cover of this user guide.

Additional resources are available to ensure a trouble-free experience with our products:

- Detailed product information on www.dymax.com
- Dymax adhesive product data sheets on our website
- Safety data sheets (SDS) provided with shipments of Dymax materials

Safety



WARNING! Using this LED controller with the associated light sources may result in injury without first reading and understanding the information in this user guide. Please read and understand the information in this guide prior to assembly and use of this device.

General Safety Considerations

All users of Dymax LED light sources should read and understand this user guide before assembling and using the system.

To learn about the safe handling and use of light-curable formulations, obtain and read the SDS for each product. Dymax includes an SDS with each fluid product sold. In addition, fluid product SDS can be requested through our website.

WARNING! Under NO circumstances should the interconnect cable from the controller to the LED emitter be connected or disconnected while power to the unit is on. This procedure is usually called “hot swapping” and should not be performed as it could cause damage to the controller or the emitter. Always power down the equipment before disconnecting or connecting any of these devices.

Safety Symbol Index

The following symbols are displayed on BlueWave MX-Series 2CH or 4CH systems. Please see below for their meanings.



Refer to Equipment Manual Before Operating Equipment



Eye Protection Required



Complies with All Listed European Directives



WEEE Directive (Waste electrical and electronic equipment must be disposed of or recycled at the nearest collection facility)



Warning! Use Caution When Operating Equipment



Product Contains an Electrostatic Sensitive Device (ESD) Internally



Warning! UV Light Hazard (Do not look directly at light)



Warning! Hot Surface

Specific Safety Considerations

The *BlueWave* MX-Series curing systems are designed to maximize operator safety and minimize exposure to light-curing energy. To use the unit safely, it must be set up and operated in accordance with the instructions in this and the respective emitter user guide. Please also read and understand the safety considerations unique to LED-curing systems as described below.



WARNING! *The controller is cooled by natural convection. If you block the air flow from the controller, equipment damage and malfunction can result. To prevent damage and malfunction, ensure adequate space around controller vents to allow the free flow of air. Typically, 1.5 in (38 mm) of space around all sides of the controller is sufficient.*

Dymax UV Light-Curing General Safety Considerations

Operators must understand these three concepts to use the LED light source safely: UV exposure, high-temperature surfaces, and bright, visible light.

UV Exposure

Standard Dymax UV light-curing systems have been designed primarily to emit UVA and Visible energy (Figure 1). Depending on the model of LED head used, the energy emitted from a *BlueWave* MX-Series curing system can either be in the upper end of the UVA portion of the spectrum (PrimeCure® and RediCure®) or in the lower portion of the visible spectrum (VisiCure®). UVA energy is generally considered the safest of the three UV ranges: UVA, UVB, and UVC. Although OSHA does not currently regulate UV-light exposure in the workplace, the American Conference of Governmental Industrial Hygienists (ACGIH) does recommend Threshold Limit Values (TLVs) for ultraviolet light.

The strictest interpretation of the TLV (over the UVA range) for workers' eyes and skin allows continuous exposure up to 1 mW/cm² (intensity). Unless you are placing bare hands into the curing area, it is unusual to exceed these limits. To put 1 mW/cm² limit into perspective, a cloudless summer day will typically exceed 3 mW/cm² of UVA light, and also include the more dangerous UVB light (primarily responsible for sun tans, sun burns, and skin cancer).

Figure 1.
UV Spectrum

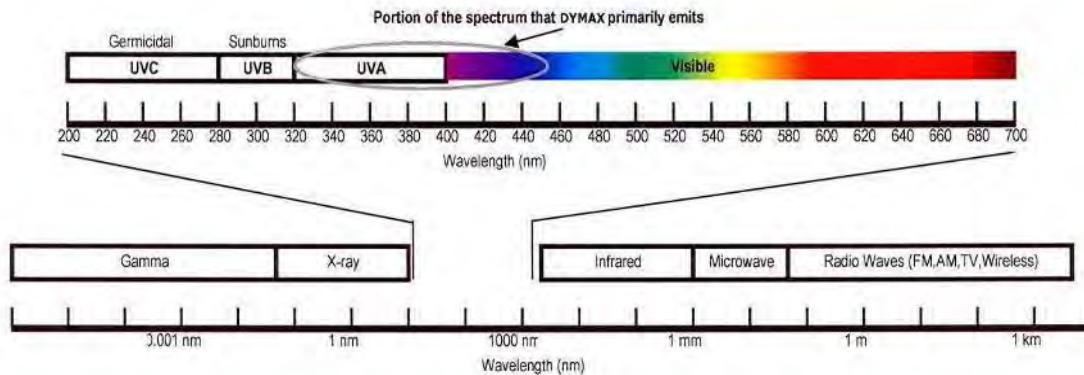

Checking the Workstation

The human eye cannot detect "pure" UV light, only visible light. A radiometer should be used to measure stray UV light to confirm the safety of a UV light-curing process. A workstation that exposes an operator to more than 1 mW/cm² of UVA continuously should be redesigned.

Protecting Operators

Light-curing technology can be a regulatory compliant, "worker-friendly" manufacturing process when the proper safety equipment and operator training is utilized. There are two ways to protect operators from UV exposure: shield the operator and/or shield the source.

Shield the Operator

UV-Blocking Eye Protection — UV-blocking eye protection is recommended when operating UV light-curing systems. Both clear and tinted UV-blocking eye protection is available from Dymax.

UV-Blocking Skin Protection — Opaque, UV-blocking clothing, gloves, and full-face shields are recommended when skin may potentially be exposed to UV light.

Shield the Source of UV

Any substrate that blocks UV light can be used as a shield to protect workers. The following materials can be used to create simple shielding structures:

Rigid Plastic Film — Transparent or translucent/UV-blocking plastics (typically polycarbonate or acrylic) are commonly used to create shielding where some level of transparency is also desired.

Flexible Film — Translucent UV-blocking, flexible urethane films can be used to quickly create workstation shielding. This UV-blocking, flexible urethane film is available from Dymax, call for assistance.

High-Temperature Surfaces

Surfaces exposed to high-intensity curing energy may rise in temperature. The intensity, distance, exposure time, cooling fans, and composition of the surface can all affect the rise in surface temperature. In some cases, exposed

surfaces can reach temperatures capable of producing a burn or causing damage to a substrate. In these cases, operators should try to minimize exposure to maintain a cooler surface temperature, or they should have the appropriate protection/training to avoid injury from the heat. Empirical testing should be used to verify the temperature rise in each application.

Bright Visible Light

The bright visible energy emitted by curing systems can cause eyestrain if proper eye protection or shielding is not used. The use of tinted eye protection and/or opaque/ tinted shielding can be utilized to reduce eyestrain and address this concern.

Dymax tests all LED equipment per IEC62471 and will mark risk group and appropriate warning on each emitter.

Product Overview

Description of BlueWave MX-Series Multichannel Controller

The BlueWave MX-series multichannel controller, when combined with MX-series emitters, provides manufacturers with the curing flexibility they need in a smaller more efficient design. The unit is comprised of two main parts: a multichannel controller with an easy-to-use touchscreen interface and up to 4 high-intensity LED emitters.

With this controller, the system can be truly tailored to users' curing needs – allowing them to choose from any of the different emitter types and different wavelength LED emitters (365, 385, or 405 nm) in three cure pattern formats; Spot, Mini-Flood and Line emission patterns. This flexibility ensures optimal cures are achieved across a variety of bond-line geometries and fluid product offerings. Users also have greater set up flexibility; for automated curing processes, the emitter can be mounted to robotic arms or further from the controller without fear of intensity variations. When used as a bench-top curing system, the unit can be paired with a stand and shielding for large area curing. It can also be used with multiple pathway lightguides for specialized applications when paired with MX spot emitters.

MX-series controllers are available in two different model variants – a two channel (2CH) that is capable of independently controlling up to two emitters, and a four channel (4CH) for up to four emitters.

Figure 2.
BlueWave® MX-250 System with 4-Channel Controller



Compatible MX-Series Emitters

- The BlueWave® MX-150 functions as a high-intensity spot-curing system. Can be used with lightguides to provide setup flexibility.
- The BlueWave® MX-250 functions as a mini- flood-curing system with a 50 mm x 50 mm (2 in x 2 in) curing area for large area coverage.
- The BlueWave® MX-275 functions as a line pattern flood-curing system with a 5 mm x 50 mm (0.2 in x 2 in) asserted curing area.
- To support the use of the multichannel controller emitters must be of firmware revision 1.08 or higher, updates can be performed at Dymax.

Figure 3.
Main Components of an MX Curing System



Features & Benefits

BlueWave MX-series modular curing systems are engineered for precise performance and long service life. Key features include:

Features	Benefits
Multichannel controllers power up to 4 MX emitters independently or as an integrated light bar	<ul style="list-style-type: none"> • Only one controller required, reducing equipment footprint and cost. • Workstations can operate independently with four separate foot pedals. • Four BlueWave MX-275 emitters produce a high-intensity 5 mm x 200 mm light bar. • Four BlueWave MX-250 emitters can be integrated to produce a 50 mm x 200 mm light bar. • Four BlueWave MX-150 emitters, each with a 4-pole lightguide, gives you 16 cure spots from a single controller.
Compatible with BlueWave MX-150, MX-250, & MX-275 emitters	<ul style="list-style-type: none"> • Utilizes existing BlueWave MX-150 and MX-250 emitters with firmware at version 1.08 or higher. Dymax can upgrade emitter firmware to the latest versions by returning to our one of our service facilities. • Provides greater flexibility to switch between LED spot and flood curing configurations. • All BlueWave MX-series emitters available in 365, 385, and 405 nm.
Provides for growth and flexibility	<ul style="list-style-type: none"> • Users can start with a single emitter and add others as their applications grow. • Allows various combinations of different BlueWave MX emitters.
Admin and production modes	<ul style="list-style-type: none"> • Production Mode for simple on/off operation. • Curing programs can be saved and recalled. • Units can be password protected in Production Mode to limit process modification.
Touch screen with improved user interface and full keyboard	<ul style="list-style-type: none"> • Each emitter is automatically recognized when plugged into the controller. • Curing programs can be entered, stored, and recalled when needed. • Stylus aids menu navigation and attaches to unit.
Immediate LED on-off	<ul style="list-style-type: none"> • Cold start capable. • More energy efficient
LED temperature management and system monitoring	<ul style="list-style-type: none"> • Maximized continuous operation without overheating. • Temperature monitoring assures maximum LED life. • Monitors critical system functions.
Remote I/O interface	<ul style="list-style-type: none"> • May be incorporated into automated systems • Improved PLC interface provides additional flexibility for automated applications.

Control Panels

Front Panel

The front panel (Figure 4) features the power button and a touchscreen display through which the unit can be operated.

Power Button — Press the power button to power up the controller. Press the button a second time to turn the unit off.

Figure 4.
Front Control Panel



Back Panel

Figure 4 shows the interface connections at the back of the multichannel controller.

Figure 5.
BlueWave MX-Series 4-Channel Controller Rear Panel

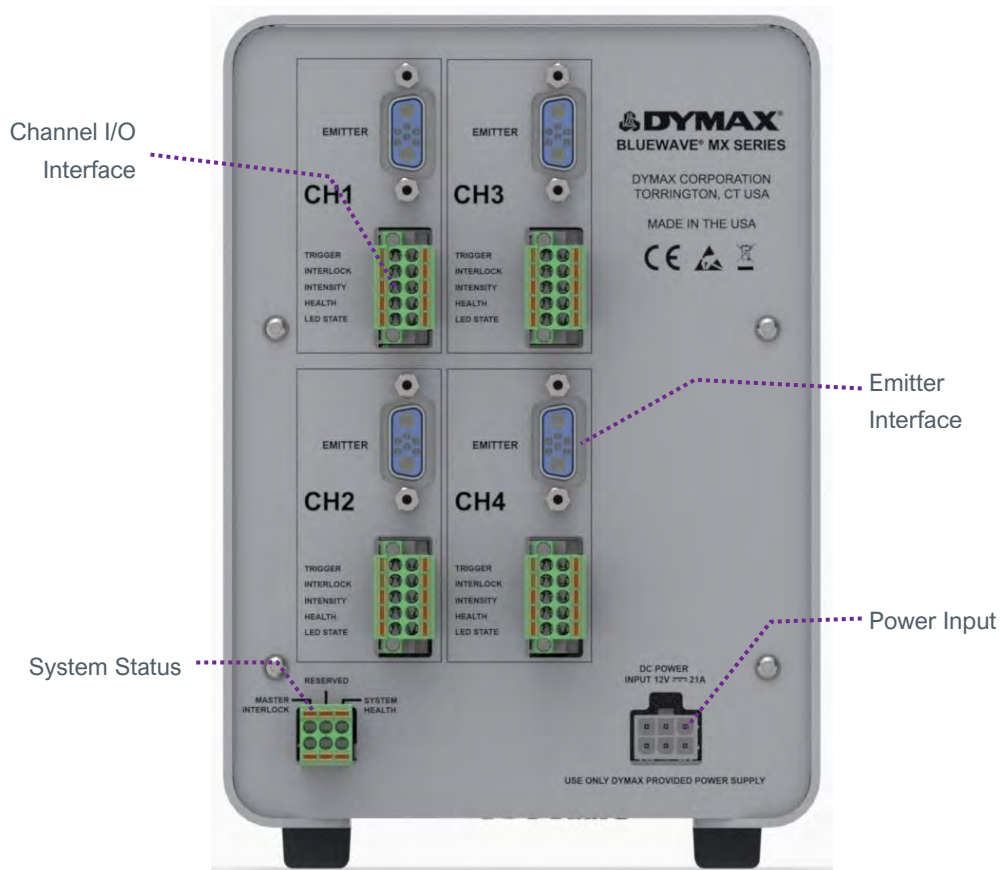
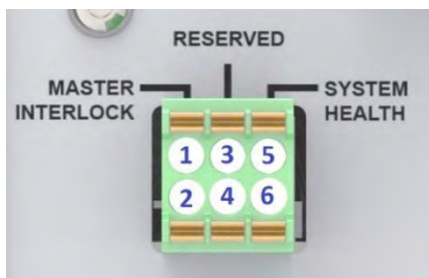
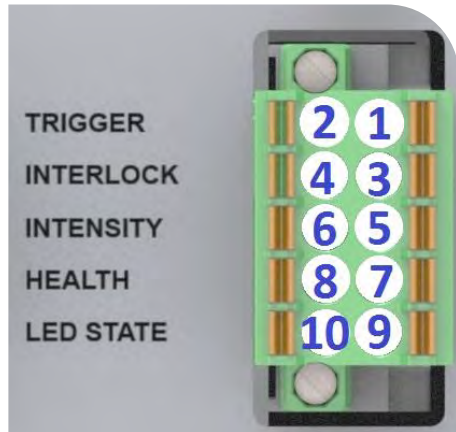

Figure 6.
System Status (Located on Rear of Controller)



- PIN 1 - Master Interlock input asserted low
(NOTE: must be asserted for unit operation, factory jumper provided)
- PIN 2 - ISO Return 1
- PIN 3 - Reserved
- PIN 4 - Reserved
- PIN 5 - System Health Output (Asserted Low No Alarms)
- PIN 6 - ISO Return 1

Figure 7.
I/O Interface



- PIN 1 - Trigger Enable Input (Asserted Low)
- PIN 2 - ISO Return 3
- PIN 3 - Interlock Input (*must be asserted for unit operation, individual channel interlock, Factory Jumper Provided*)
- PIN 4 - ISO Return 3
- PIN 5 - Analog (0 to 10 Volts) Intensity input
- PIN 6 - ISO Return 2
- PIN 7 - Emitter Health Output (Asserted Low No Alarms)
- PIN 8 - ISO Return 3
- PIN 9 - LED State Output (Asserted Low LED In on)
- PIN10 - ISO Return 3

Unpacking

Unpacking and Inspecting Your Shipment

Upon arrival, inspect all boxes for damage and notify the shipper of box damage immediately. Open each box and check for equipment damage. If parts are damaged, notify the shipper and submit a claim for the damaged parts. Contact Dymax customer service for replacement parts.

The parts below are included in every package/order. If parts are missing from your order, contact your local Dymax representative or Dymax Customer Support to resolve the problem.

Parts Included

- Controller
- Power Supply
- Power Cord
- BlueWave MX-Series Multi-Channel Controller User Guide
- I/O interface connectors
- Stylus Kit
- Goggles

NOTE: Interconnect cables and footswitches are sold separately.

System Setup

System Connections

NOTE: Although this product is designed with protection against ESD (Electrostatic Discharge) it is recommended to take precautions against static when handling the BlueWave MX-Series controller or LED emitter independently. Once these devices are attached together through the interconnect cable, then the threat of ESD damage is eliminated.

1. Attach the power cord to the power supply and attach the DC to the Power Input Receptacle located on the unit's back panel (Figure 5).

2. At the top of the Controller's Rear Panel, there are connectors labeled "Emitter" (Figure 5). Connect the male end of the Emitter Cable to this connector and the female end to the Emitter. Each "Emitter" uses its own cable, the system supports four separate emitters.
3. When not using PLC controls or footswitches, install the supplied PLC connector with installed Interlock jumpers into the Channel I/O interface terminal for each channel that is installed.

WARNING! Under no circumstance should the interconnect cable from the BlueWave MX-Series controller to the LED emitter be connected or disconnected while power to the unit is on. This procedure is usually called "hot-swapping" and should not be performed as it could cause damage to the controller or the LED emitter. Always power down the equipment before disconnecting any of these devices.

4. The Master Interlock input must be installed using the supplied connector with jumper. (PIN 1) must be connected to common (PIN 2) for normal operation. The Master Interlock will shut off all 4 emitters if not installed.
5. Plug the power cord from the power supply into an appropriate AC power source. The unit is now powered and ready to be turned on with the On/Off Switch located on the front of the unit.

WARNING! If the BlueWave MX-Series controller is powered on with no LED emitter connected, the controller screen will not show the banner containing the information of the emitter type or wavelength and indicate NOT READY.

6. If using the optional foot pedal, plug it into the Channel I/O interface terminal on the rear panel of the controller. This will have an integral interlock jumper.

If you are using a PLC, there are input and output, (I/O) Connection Terminals that can be used to integrate the unit to an automated assembly line. Refer to the PLC Section of this manual. Refer to Table 1 and Figure 11-17 for more complete description of the I/O interface and wiring examples.

7. Your unit is now ready for operation.

Modes of Operation

The system has three basic modes of operation: Manual, Timer, and PLC. The controller can have each channel triggered independently or in groups based on trigger settings. Trigger actions can be via touch screen, footswitch or PLC command interface.

Manual Mode

When in manual mode, the time indicator will start at zero. The time will count up if the associated trigger input is actuated (asserted) and the LED is energized. When the associated input trigger; touch screen, foot pedal or PLC Input, is deactivated (deasserted) the time will stop counting and LED is de-energized.

Timed Mode

In timed mode, the LED is energized for a specific time each time the channel trigger input is asserted. The specific time is set by adjusting the time variable through the touchscreen user interface. Momentarily asserting the channel

trigger input starts the timer, energizes the LED and counts down. See the Input/Output Interface section for timing details.

When the timer counts down to zero, the LED is de-energized, and no curing energy is emitted. The timer is reset to the pre-set value, and the system is immediately ready to run another exposure cycle. The LED can be de-energized at any time during the curing cycle by simply reasserting the correct trigger input a second time.

PLC (Programmable Logic Controller) Operation

When in PLC mode, an external PLC can control the unit. The PLC provides input signals to the BlueWave MX-Series 2CH & 4CH system to control the on/off signals and intensity of the LEDs. The PLC monitors the status of the system by reading output signals provided by the unit.

An example of the appearance of the PLC Mode screen is shown in Figure 8. See PLC Screen section for detailed description of content.

The PRG-EXT Display Button, shown in grey background on the PLC mode screen is used to choose between programmed or externally controlled intensity.

NOTE: When you initiate PLC mode you have the option to SET PROG/EXT. PROG mode will use the program that has been selected via the GUI. EXT mode will use analog intensity inputs to set intensity, the LED will be on as long as the trigger input is asserted. Minimum LED on/off time is 200 msec.)

Figure 8.
PLC Mode Screen

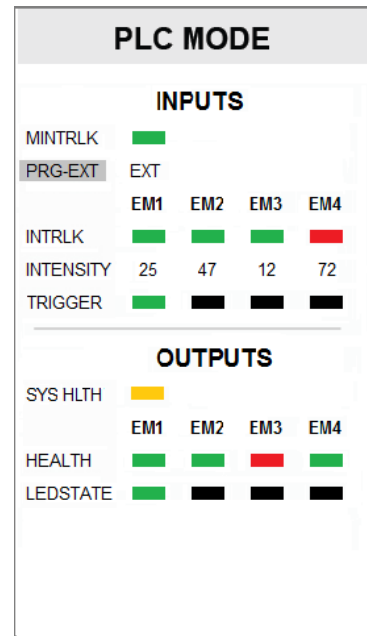

Input/Output Interface

Figure 9. Channel I/O Interface (Located on Rear of Controller)

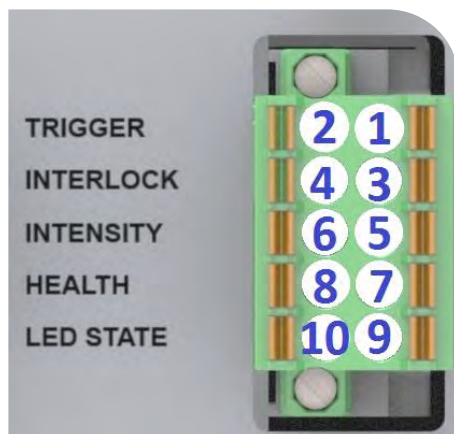

- PIN 1 - Trigger Enable Input (Asserted Low)
- PIN 2 - ISO Return 3
- PIN 3 - Interlock Input (*must be asserted for unit operation, individual channel interlock, Factory Jumpers Provided*)
- PIN 4 - ISO Return 3
- PIN 5 - Analog (0 to 10 Volts) Intensity input
- PIN 6 - ISO Return 2
- PIN 7 - Emitter Health Output (Asserted Low No Alarms)
- PIN 8 - ISO Return 3
- PIN 9 - LED State Output (Asserted Low LED In on)
- PIN10 - ISO Return 3

Table 1.
I/O Interface

Signal Name / Description	Isolated Inputs/ outputs	Connector-Pin	Signal GND	Signal Level	
				Asserted	De-Asserted
I/O INPUTS					
Trigger (Minimum pulse width = 30 msec.) Used to start and stop curing cycles	IN	1	2	0 VDC (Shorted to pin 2)	24 VDC (Open)
Interlock Input Signal must be asserted for emitter function Momentarily breaking the connection via customer supplied relays or switch contacts will deactivate the emitter. FACTORY JUMPERS PROVIDED WITH UNIT.	IN	3	4	0 VDC (Shorted to pin 4)	24 VDC (Open)
Intensity Input Only used in PLC – EXT mode Sets emitter intensity level (1V=10% output, 10V=100%)	IN	5	6	0 – 10 VDC	N/A
I/O Outputs					
Emitter Health Output (Max. 100 msec for update) Indicates health of each emitter	OUT	7	8	NO Alarm 0 VDC	24 VDC Alarm
LED State Output (Max. 100 msec after state change) Indicates current state of each emitter	OUT	9	10	0 VDC On	24 VDC Off

Figure 10.
System Status (Located on Rear of Controller)

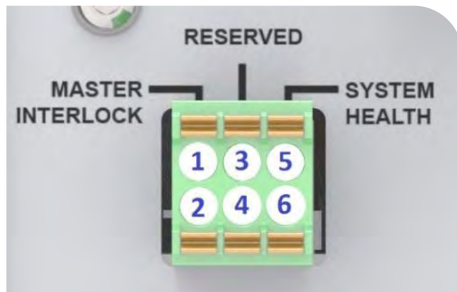

PIN 1 - Master Interlock input asserted low (*NOTE: MUST BE ASSERTED FOR UNIT OPERATION, Factory Jumper Provided*)
 PIN 2 - ISO Return 1
 PIN 3 - Reserved
 PIN 4 - Reserved
 PIN 5 - System Health Output (Asserted Low No Alarms)
 PIN 6 - ISO Return 1

Table 2.
Master & System Health Inputs and Outputs

Signal Name / Description	Isolated Inputs/ outputs	Connector-Pin	Signal GND	Signal Level	
				Asserted	De-Asserted
Master Interlock Input Momentarily breaking the connection via customer supplied relays or switch contacts will deactivate all emitters FACTORY JUMPER PROVIDED	IN	1	2	0 VDC (Shorted to pin 2)	24 VDC (Open)
RESERVED No Connection	n/a	3	4	n/a	n/a
System Health Output Asserted while there are no Errors always active	OUT	5	6	0 VDC	24 VDC

Examples of PLC Wiring

Figure 11.
PLC Interface Using Dry Contact Switches

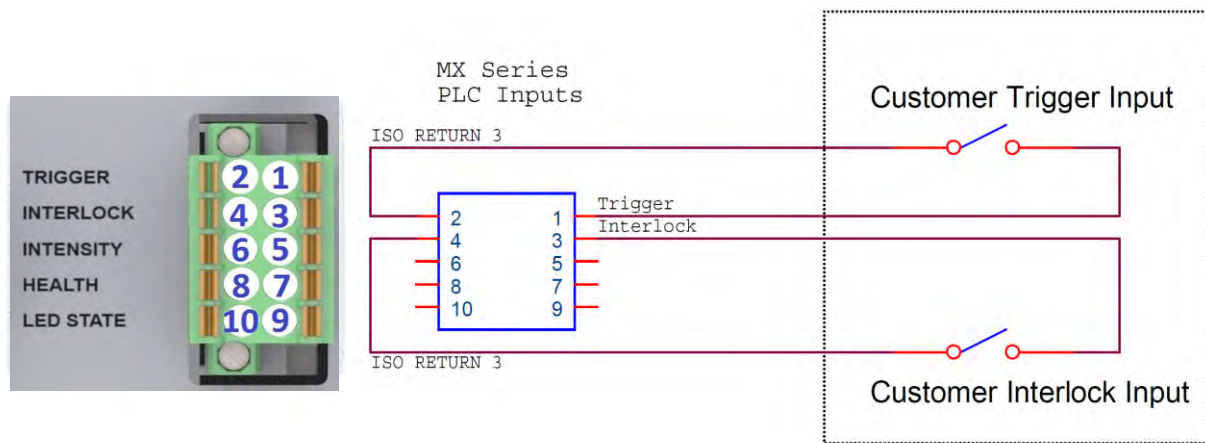

Figure 12.
PLC Interface for intensity Control

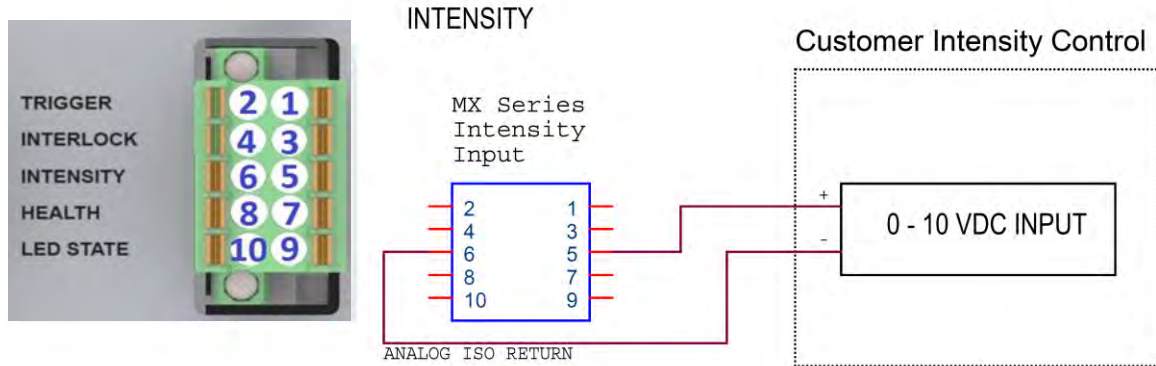

Figure 13.
PLC Discrete Status Outputs Typical Relay and Optical Isolation

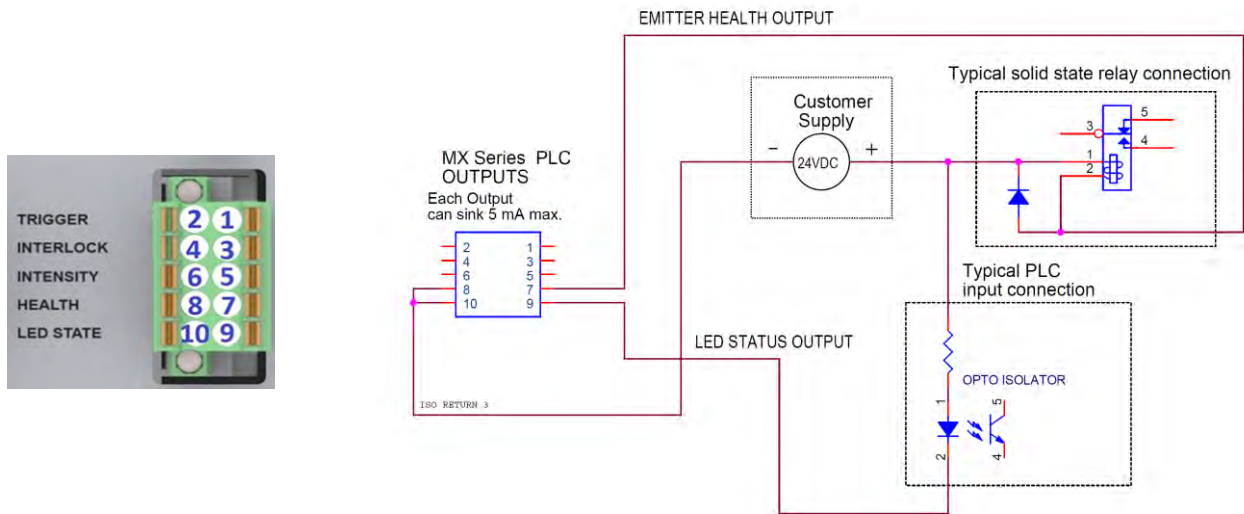
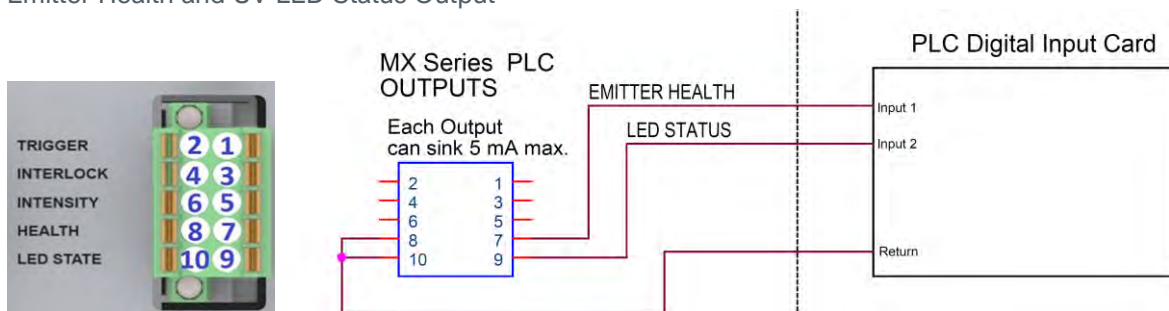

Figure 14.
Emitter Health and UV LED Status Output



NOTE: The PLC status outputs have a maximum sink current of 5 mA each. It is recommended to use a solid-state relay with a control current <5 mA where relays are shown in Figure 13 and Figure 16.

Recommended Relays: Weidmuller 8820710000, Phoenix Contact 2980636

Examples of Master Interlock / System Health Wiring

Figure 15.
Master Interlock Switch Input

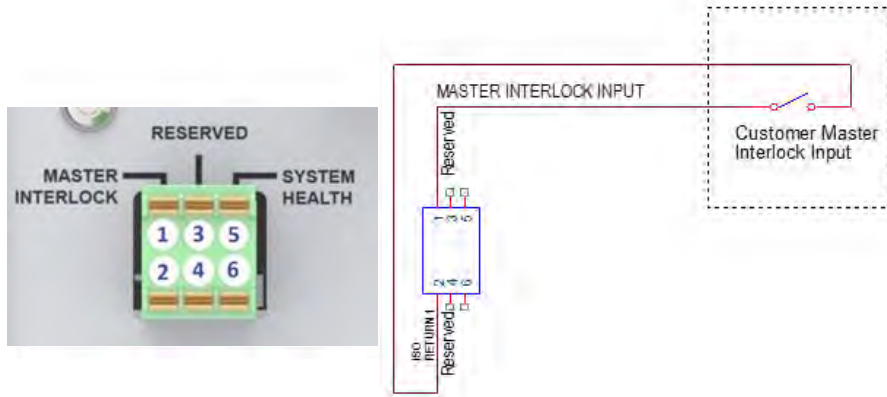

Figure 16.
System Health Output typical relay / typical PLC Connection

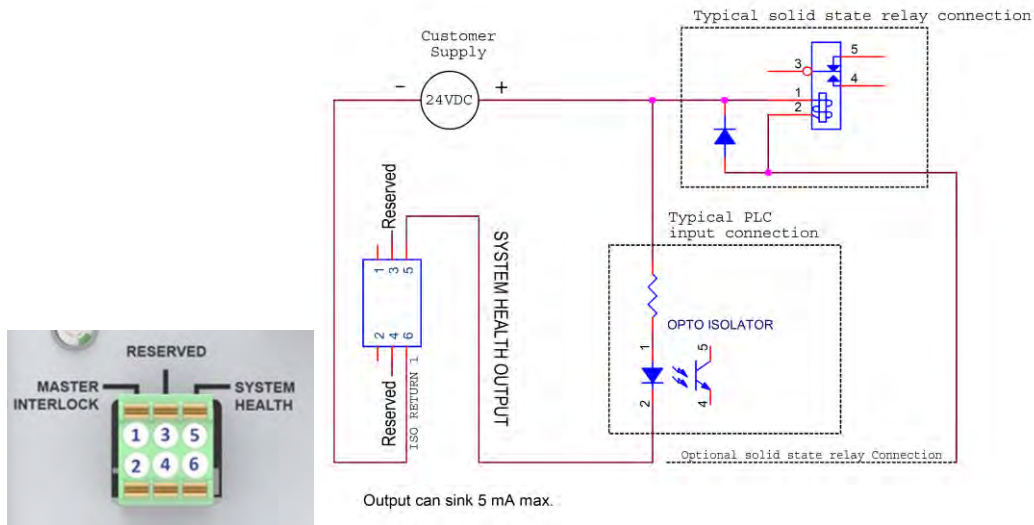
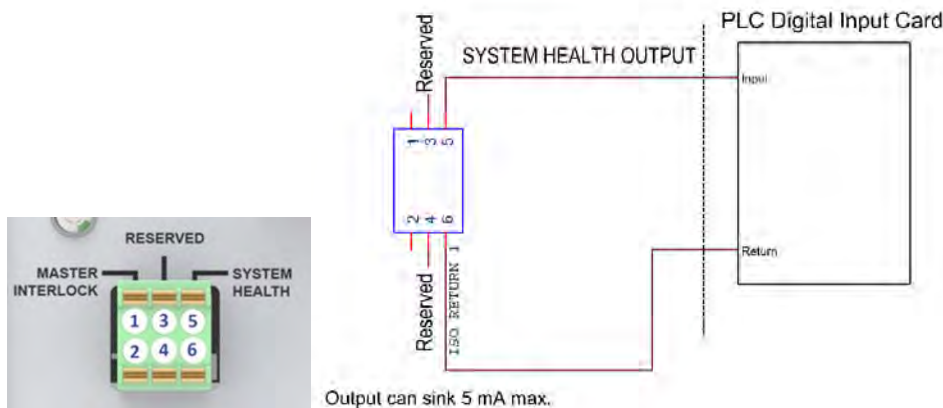

Figure 17.
System Health Output to PLC Digital



Operation

To operate the controller, first verify that all Connectors are correctly plugged into the rear panel of the unit (See *System Connections*, pg. 12 for more details). When all Connectors are properly plugged in, press the Power Button on the front panel of the unit.

Upon startup of the unit, a splash screen will appear. After 6 seconds, the control screen should appear in the display. It will be in administrator mode the first time the unit is started.

Admin Screen

The control screen is used to set up and run curing cycles. This screen allows users to switch back and forth between Administrator, Production and PLC modes. It is also where the curing parameters are set.

Figure 18.
Admin Screen

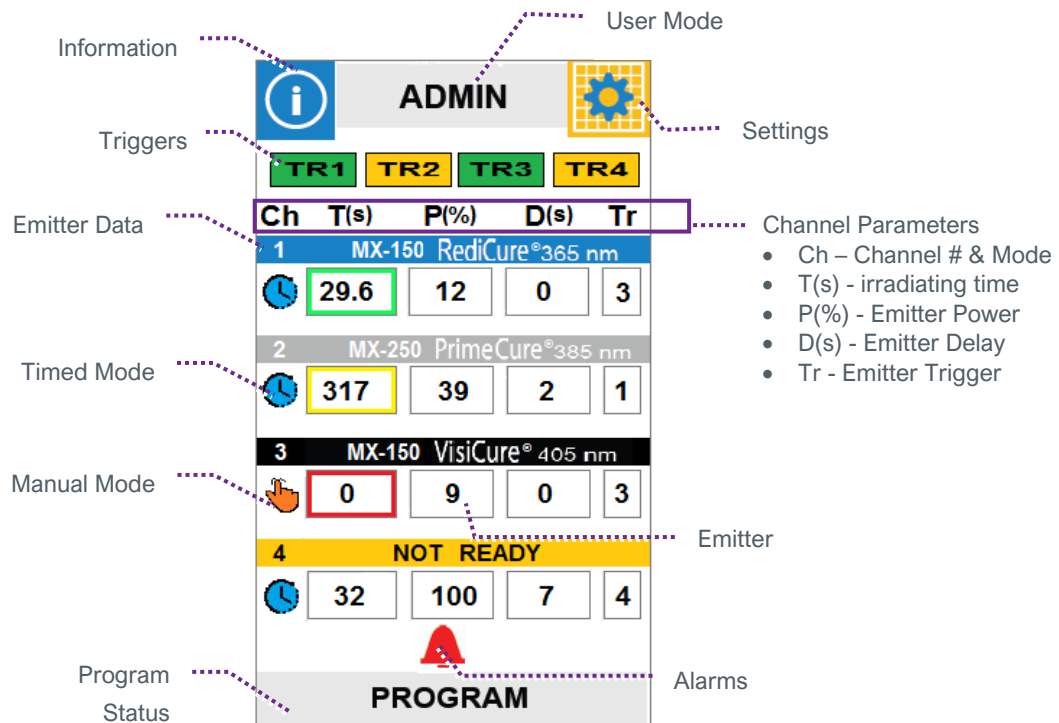

Touch Screen Interface

The touch screen uses two types of inputs via the touch screen:

- **Buttons (B)** which executes an action
- **Display/Buttons (DB)** which indicates a status or parameter but also functions as a button

The following are general descriptions of the inputs found on the system touch screens. The type of input is denoted by a (B) or (DB) next to the name.

 **Information (B):** Advances to system information screen.

User Mode (DB): The current user mode (Admin, Production, or PLC) will be displayed on the gray button at the top of the screen between the information and setting buttons. Pressing this button switches between Administration, Production and PLC modes. A password will be required to enter administrator mode.

In Production Mode the production screen layout is identical to the administrator screen with the exception it does not have trigger (TR1-4) buttons. The configuration settings reflect the administrator settings and cannot be altered. User operational controls are limited to Volume and Brightness (see Settings screen). Program(s) names will be displayed along with the emitter type but the ability to save and load program(s) will be disabled. The default password is 1234.

 **Settings (B):** Loads the settings screen where the volume, language, screen brightness, and other user settings can be adjusted.

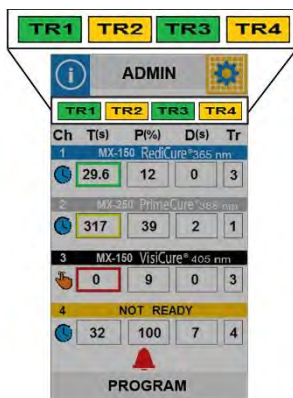

Triggers (DB): “TR1-TR4” – (Admin Screen Only) Displays the current state of the 4 input triggers (Green - Active (Asserted); Yellow - Inactive (Deasserted)).

NOTE: During a cure cycle pressing these will stop any LED emitter operation.

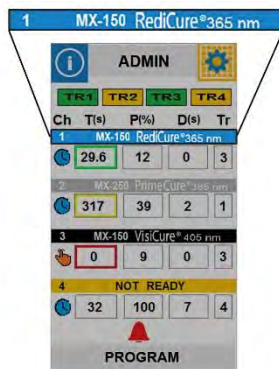

Emitter Type Display/ Wavelength (1-4): Each emitter will have a horizontal banner which will display the emitter number, emitter type, and emitter wavelength.

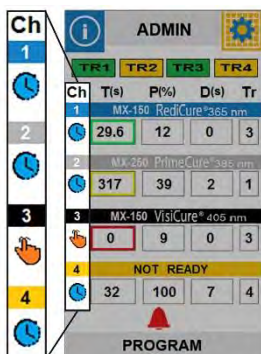

Mode (1-4) (DB): This button, located in the first column under the channel number, displays the current mode of operation for each channel (timed or manual) that is attached to an emitter.



Timed Mode (B): Pressing this button will put this emitter into manual mode and clear the emitter time.



Manual Mode (B): Pressing this button will put this emitter into timed mode and set the emitter time to the current displayed time.



Irradiating Time (DB) (1-4): The irradiating time for each channel is displayed in the second column under the heading T(s). When in timed mode, time is entered by touching the T(s) button, which in turn brings up a numerical keypad for entry. The entry range is 0.1 – 999 seconds. From 0.1 – 30 seconds the adjustment is made in 0.1 second increments and from 30 – 999 seconds the adjustment is made in 1 second increments.

The button will display a colored highlight in the following situations:

- Yellow highlight - emitter time is waiting for delay time to expire.
- Green highlight - emitter is ON.
- Red highlight - emitter alarm.
- No highlight - emitter ready.



Emitter Power (DB) (1-4): The cure power level is displayed as a percentage in the third column, under the heading P(%). Pressing this display field will advance the unit to the power level screen. Power may be set from 5-100% in 1% increments.

Note: Always use the lowest power setting to achieve cure to extend emitter life.

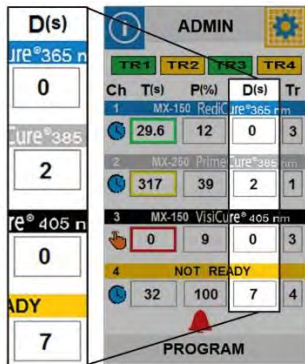

Emitter Delay (DB) (1-4): The cure delay is displayed in the fourth column under the heading D(s). This is a delay between the emitter trigger being activated and the emitter irradiation. Pressing this display field advances to the delay time screen.



Emitter Trigger (DB)(1-4): The emitter trigger button is located in the fifth column under the heading Tr. It displays the trigger number used by each emitter to start the curing process. When this button is pressed, the trigger number will increment up. By setting common trigger number, multiple emitters can be triggered simultaneously by a single trigger input.

Program (DB): The area on the bottom of the screen is reserved for displaying the current program name. If a program has not been selected or has not been created this area will display “PROGRAM”. This area also serves as a button that when pressed will bring the user to the program screen where the current setup may be saved or a saved setup may be loaded (See Loading and Saving Programs on next page).



Alarm Icon (DB): The alarm icon will be displayed whenever the system has an alarm that the user should be aware of. Pressing the Alarm Icon advances to the alarm screen. (See Alarms section Page 32).

Irradiation

To run a curing cycle in manual mode:

1. Set the channel to Manual Mode by hitting the Mode (DB). Hand icon should appear.
2. Input the Power, Delay and Trigger value as needed by pressing the respective button.
3. Assert the associated input to start the irradiation. The timer field will begin counting. The irradiation will terminate when the associated trigger input is deasserted.
4. When in manual mode, the time indicator will start at zero. While the associated trigger input is asserted the time will count up until the associated trigger input is deasserted or it reaches 999 seconds. The time value will remain displayed. Starting a new exposure will reset the time value to zero immediately and proceed to count up.

There is a time delay up to 50 milliseconds from assertion to LED irradiation.

To run a curing cycle in timed mode:

1. Set the channel to Timed Mode by hitting the Mode (DB). Clock icon should appear.
2. Input the Time, Power, Delay and Trigger values by pressing on each respective button.
3. Assert the associated trigger input to start the timed irradiation. The irradiation will terminate when the count reaches zero. The timed exposure may be aborted at any time by reasserting the associated trigger input.
4. After the timed exposure, the time value will be automatically reloaded in preparation for the next activation

Note: The BlueWave multi-channel controller system supports accurate LED activation as short as 0.1 seconds.

It is possible for users to type in a time setting greater than 3 digits during time entry. However, the BlueWave multi-channel controller will default to 999 seconds.

Loading and Saving Programs

The curing settings (program) may be saved to internal memory by highlighting a program name and pressing “SAVE”, which will bring up a QWERTY keyboard for program name entry. Previously saved programs may be recalled by highlighting the desired program name and pressing “LOAD”. The Back button will return the user to the previous screen.

When entering program names for different curing settings, utilize a dash or dot to separate words as the use of a “space” is not supported by this system.

To load a curing program, press the Program Button on the bottom of the screen. A list of available programs will appear. Select the appropriate one and press “LOAD”. The program will load and you will be brought back to the Control Screen.

System Screens

System Information

The System Information Screen can be accessed by pressing the Information Button in the top left corner of the Production or Admin Screens. Information such as the controller model number and the serial number, firmware revision, and run hours for the Emitter can be found here.

This screen has two main buttons, the Channel Select Button and the Alarms Display Buttons. Pressing the Channel Button insert scrolls through each emitter’s data. Pressing the Alarm display button will access the Alarms Screen.

Figure 19.
Information Screen

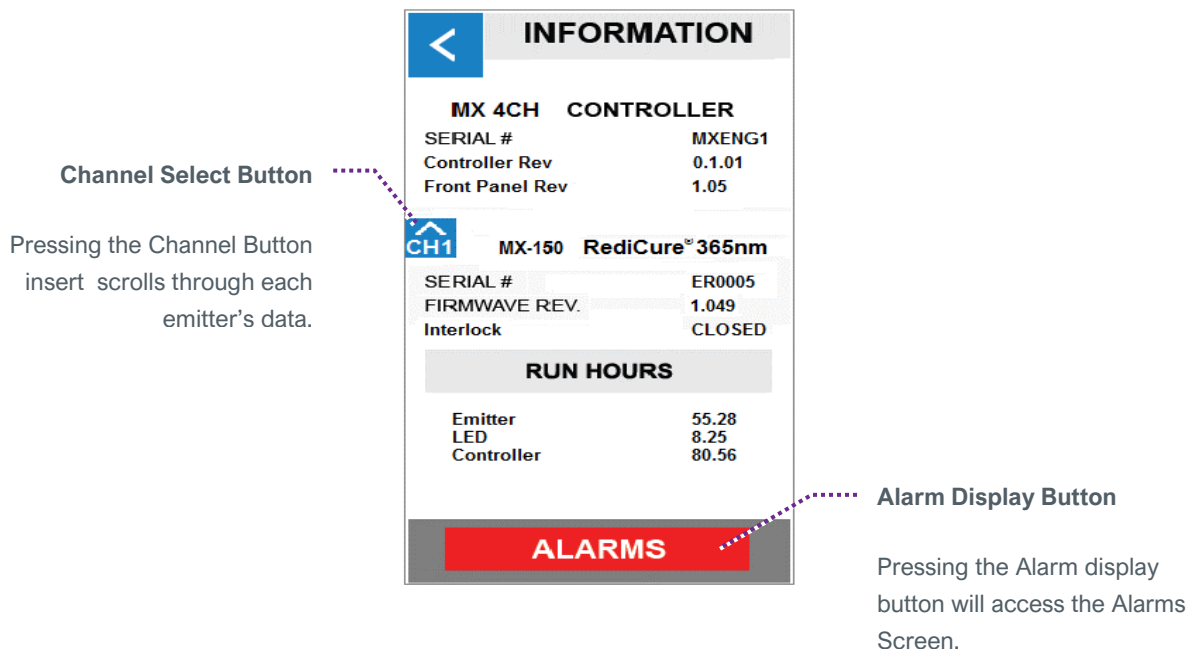

Curing Time Screen

By pressing the Time Display/Button for an individual channel you can access the timer setting.

Figure 20.
Time Display/Buttons

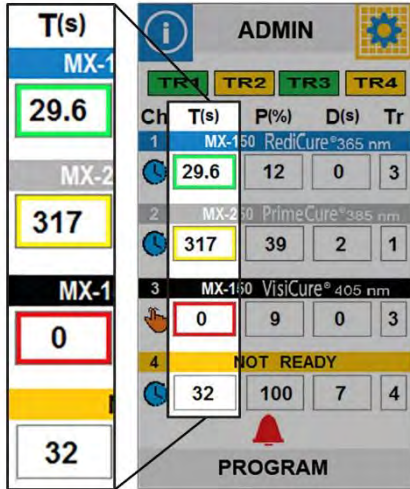
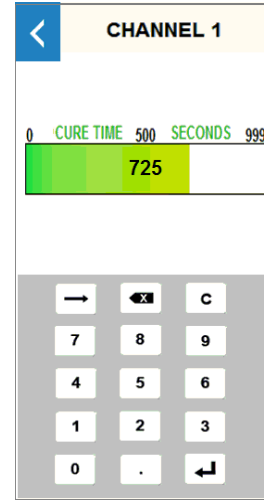

Figure 21.
Cure Time Settings Screen



The entry range is 0.1 – 999 seconds. From 0.1 – 30 seconds the adjustment is made in 0.1 second increments and from 30 – 999 seconds the adjustment is made in 1 second increments. Entering a “0” places this emitter into manual mode.

You must press the carriage return button to enter a value, pressing the “back” button will abort the command.

Power Level Screen

By pressing the Power Display/Button for each channel you can access the power setting.

Figure 22.
Power Display/Buttons

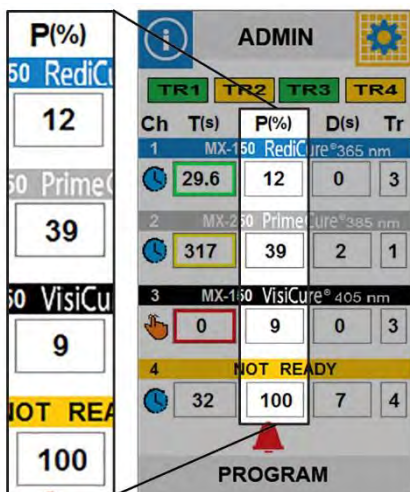
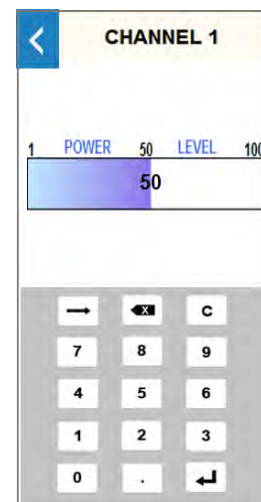

Figure 23.
Power Level Settings Screen



This screen allows the user to enter the power level for each emitter. The power level range is 5 to 100% in increments of 1%.

You must press the carriage return button to enter a value, pressing the “back” button will abort the command.

Cure Delay Screen

By pressing the Delay Display/Button for each channel you can access the delay setting.

Figure 24.
Delay Display/Buttons

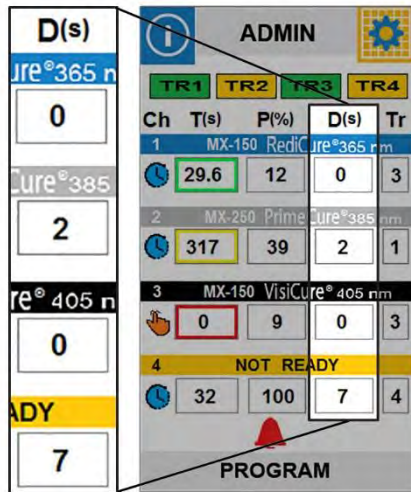
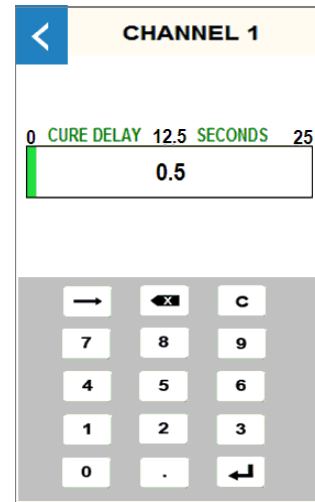

Figure 25.
Cure Delay Settings Screen



This screen allows the user to enter the delay time for each emitter. The entry range is 0.1 – 25 seconds. From 0.1 – 10 the adjustment is made in 0.1 second increments and from 10 – 25 the adjustment is made in 1 second increments.

This delays the start of the emitter from the time the trigger input is initiated to when the LED is commanded ON.

You must press the carriage return button to enter a value, pressing the “back” button will abort the command.

Production Screen

The Production screen layout is identical to the administrator screen with the exception it does not have TR (trigger) buttons.

All buttons will be disabled except the following:

Information, Production, Settings and Alarm Icon.

NOTE: The user may move to PLC mode by pressing the Production Button at the top of the screen. The password to return to the admin screen is “1234”. If the wrong password is entered it will go back to the production screen. See the password section for setting and changing passwords.

Figure 26.
Production Screen

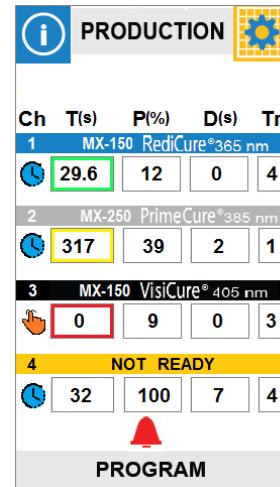

PLC Screen

The PLC Mode screen display the inputs and outputs shown in Figure 27 along with their current states/settings.

Figure 27.
PLC Inputs & Outputs

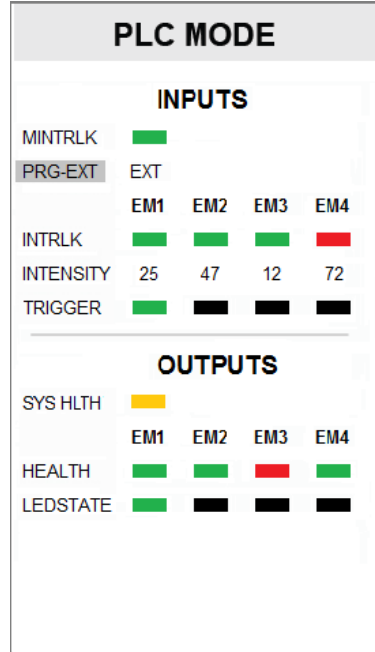

PLC MODE	
Display/Button: Displays current user (Admin, Production, PLC)	
Inputs	
MINTRLK	MASTER INTERLOCK STATUS
PRG-EXT	PROGRAM/EXTERNAL Display Button is used to choose between programmed or externally controlled intensity.
INTRLK	EMITTER INTERLOCK STATUS (1-4) Displays the analog input value when in External “EXT” mode, “PRG” in Program.
INTENSITY	INTENSITY SETTING (1-4)
TRIGGER	TRIGGER STATUS (1-4)
Outputs	
SYS HLTH	SYSTEM HEALTH
HEALTH	EMITTER HEALTH (1-4)
LEDSTATE	LED STATUS (1-4)

Program Screen

The current configuration settings (program) may be saved to internal non-volatile memory by highlighting any program name and pressing “SAVE” which advances to the Enter Program Name screen (See Below) for program name entry. Previously saved programs may be recalled by highlighting the desired program name and pressing “LOAD”.

Program Name Screen

The Program Name field will accept an alpha-numeric name of up to 10 characters.

Settings Screen

LANGUAGE – Future support for multiple languages

VOLUME – Opens the volume screen where a slider type control will allow the adjustment of the alarm annunciator.

BRIGHTNESS – Opens the brightness screen where a slider type control will allow the adjustment of the LCD backlight.

USER – While in Admin mode opens the user screen where system startup mode (Admin/Prod/PLC) can be selected and the Admin password may be accessed.

Figure 28.
Program Screen

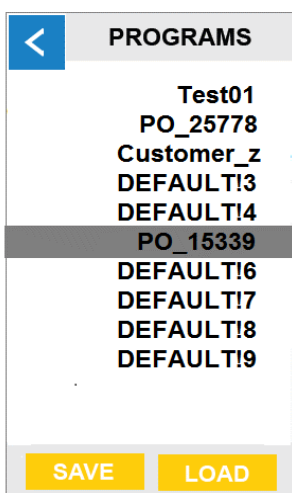

Figure 29.
Program Name Screen

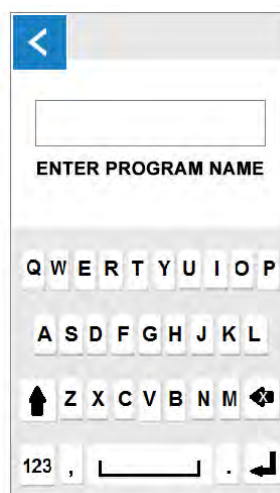
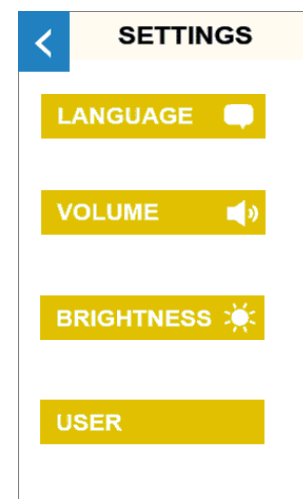

Figure 30.
Settings Screen



User Screen

User Modes

ADMINISTRATOR - controller enters Administrator mode immediately after power-up.

PRODUCTION - controller enters production mode immediately after power-up.

PLC – controller enters PLC mode immediately after power-up.

PASSWORD - Pressing the Password button advances to the New Password screen (See Password section).

DONE – Button to save current settings and return to the previous screen. Using the “back” button will abort the command.

New Password Screen

The password is entered and confirmed in the password screen via the QWERTY keyboard. The Password fields shall accept an alphanumeric password of up to 10 characters.

Troubleshooting & Maintenance

Product Cleaning

Product cleaning is limited to wiping the product with a damp cloth. Do not soak. Isopropol Alcohol and mild detergent may be used for cleaning the product.

Figure 31.
User Modes Screen

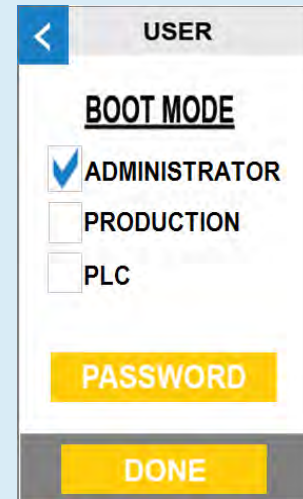
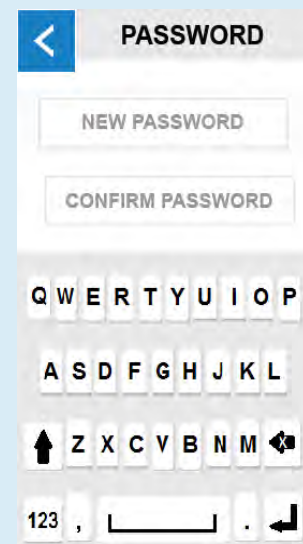

Figure 32.
New Password Screen



System Information

The System Information screen provides configuration information for the controller and the emitters attached to it.

The ALARMS button may be used to access the Alarms Screen. (See Alarm Section)

Alarms Screen

The Alarm Screen will display the current status of the controller and each emitter. The following is a list of possible alarms.

Alarms	
Emitter1-4 Interconnect Cable	Cable connection is compromised at startup
Emitter1-4 Lost Communication	Cable connection compromised while running or emitter communication failure.
Emitter1-4 Firmware Error	Firmware has found a conflict in the operation.
Emitter1-4 Light Guide Not Installed	Emitter1-4 Light guide must be present, MX-150 Only
Emitter1-4 LED Over-Temperature	LED has reached its upper thermal limit.
Emitter1-4 Error	General Errors detected by system. (Open LED, shorted LED, over-current)
Emitter1-4 LED Over-Current	Current monitoring detected LED current above limit.
Emitter1-4 Fan Speed Low	Fan PWM/Tach signal is not detected.
Controller Temperature Failure	Controller board temperature above limit.
Controller Voltage Failure	Input Voltage below threshold value.
Controller FRAM Failure	Problem detected with memory.

RESET ALARMS BUTTON - Pressing this button will reset all alarms, however if the error causing the alarm persists the alarm will continue to be asserted.

Figure 33.
System Information Screen

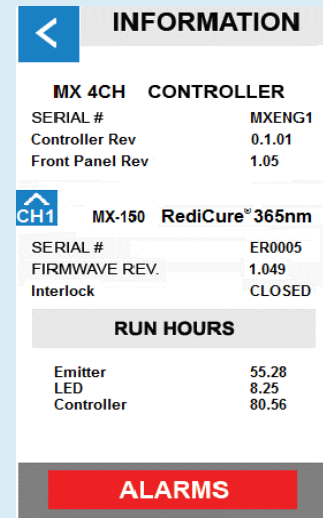
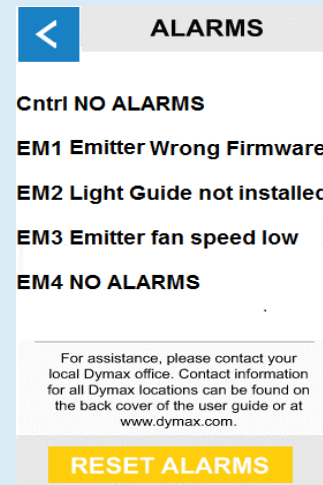

Figure 34.
Alarms Screen



Troubleshooting

WARNING! Only qualified maintenance personnel should attempt the following procedures:

Table 3.
Troubleshooting Chart for BlueWave MX Series Multichannel Controller

Problem	Possible Cause	Corrective Action
BlueWave MX controller does not power up	Power cord not plugged in or damaged	Check power connection and condition at power supply “Brick” and controller.
	No electrical power at Receptacle	Test Receptacle for power.
BlueWave MX controller powers up but the LED head does not produce light	LED intensity adjustment set to 0% or too low.	Increase LED intensity setting.
	LED cycle time is set to 0 seconds	0 Seconds sets Manual Mode and requires a trigger.
	Interlock is open.	Verify interlock jumpers are in place. Verify PLC command structure for PLC mode.
	Interface cable connections loose or damaged	Check connections and condition of Interface Cable.
	Trigger setting not matched to input.	Trigger setting on Admin screen should match the desired input trigger channel.
	LED head is not connected to the correct port/channel	Verify that the head is connected to the desired port/channel.
BlueWave MX controller is operating normally and the head suddenly stops producing light	Over-temperature shutdown was triggered	Verify alarms.
	Interlock is open.	Verify interlock jumpers are in place. Verify PLC command structure for PLC mode.
LED head provides only low-intensity light	LED intensity adjustment set to minimum	Increase LED intensity setting on Admin Settings or I/O input for PLC Mode.
	Contaminated/dirty lens optics	Clean the surface of the Lens.
Footswitch does not function correctly	Footswitch not connected or connected to wrong channel.	Connect footswitch and verify channel match to trigger setting on Admin screen.
	Multiple channels set to one trigger.	Any channel with the same trigger as the intended head will trigger too. Set to separate trigger number.
	Footswitch defective	Activate unit using the front control panel. Replace the footswitch if the unit operates from the front control panel.

Alarm Codes: MX-4E

2	No MX-4E found at Power up.
6	MX-4E Wrong Firmware
7	Controller Lost Comms with MX-4E
8	Emitter Interlock is Open
103	LED Current Draw is Wrong for Set Intensity
110	MX-4E Wand1 Over Temperature
111	MX-4E Wand2 Over Temperature
112	MX-4E Wand3 Over Temperature
113	MX-4E Wand4 Over Temperature
114	MX-4E Wand1 Fault
115	MX-4E Wand2 Fault
116	MX-4E Wand3 Fault
117	MX-4E Wand4 Fault
118	MX-4E Wand1 Lost Comms
119	MX-4E Wand2 Lost Comms
120	MX-4E Wand3 Lost Comms
121	MX-4E Wand4 Lost Comms

MX-4E Extension Module

Please refer to the MX-4E User Manual for detailed operating instructions.

The MX-4E is an expansion module that will interface with the BlueWave MX-series multichannel controllers, as well as with the BlueWave MX-MIM machine interface module, to operate existing BlueWave® QX4 LED heads.

The BlueWave MX-series multichannel controller's main screen will identify the MX-4E expansion module using a purple banner and the words "MX Expansion Module" (Figure 35).

The system information display will indicate the configuration of the expansion module and the BlueWave QX-4 LED heads will be identified by type (Redi, Prime, Visi, or none).

All controls available to any BlueWave MX-series emitter may be used. The display will read the channel order as CH1, CH2, CH3, CH4.

Expansion module hours are accumulated but will not reset when a BlueWave QX-4 head is replaced. It is suggested to monitor QX-4 Head hours separately for process control. The MX-4E is tracked as "Emitter" under Run Hours.

Figure 35.
Controller Main Screen Identifying MX-4E

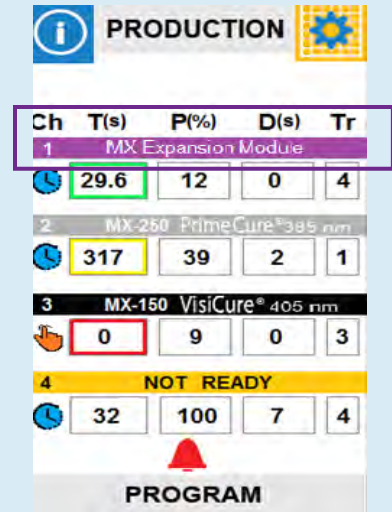
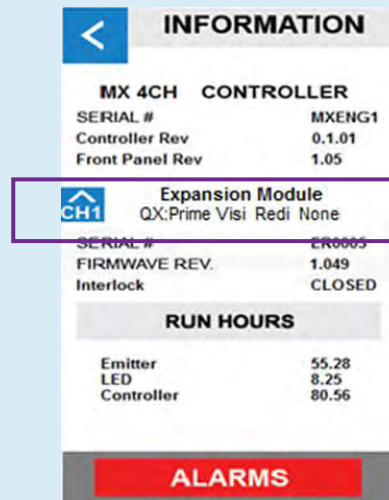

Figure 36.
System Information Screen Identifying MX-4E



Spare Parts & Accessories

Accessories

Item	Part Number
Personal Protection Equipment	
Protective Goggles — Green	35286
Protective Goggles — Gray (standard model included with unit)	35285
Face Shield	35186
Radiometer	
Dymax ACCU-CAL™ 50-LED Radiometer	40505
Stands	
Dual Emitter Mounting Bracket	60868
Three-Sided Acrylic Shield	41395
Array Stand	43070

Components & Spare Parts

Item	Part Number
Emitters	
BlueWave MX-150, VisiCure (405 nm)	42338
BlueWave MX-150, PrimeCure (385 nm)	42337
BlueWave MX-150, RediCure (365 nm)	42336
BlueWave MX-250, VisiCure (405 nm)	42808
BlueWave MX-250, PrimeCure (385 nm)	42807
BlueWave MX-250, RediCure (365 nm)	42806
BlueWave MX-275, VisiCure (405 nm)	43102
BlueWave MX-275, PrimeCure (385 nm)	43098
BlueWave MX-275, RediCure (365 nm)	43094
Key System Components	
AC Power Supply	43089
Foot Switch	43106
Foot Switch, 10-Meter Extended Cable	43496
Interconnect Cable, 2 Meter	42287
Interconnect Cable, Short, 12 Inches	43453
Extended Interconnect Cable 10 Meter	43010
Extended Interconnect Cable 20 Meter	43011

Item	Part Number
Power Cords	
Power Cord, North America	35255
Power Cord, Type G	40542
I/O Connector Kit	
I/O Connector Kit for MX 4CH Controller	43229
I/O Connector Kit for MX 2CH Controller	43230
MX-4E Expansion Module Components	
MX-4E Expansion Module	43617
LED Heads	
RediCure® (365 nm)	43163
PrimeCure® (385 nm)	43162
VisiCure® (405 nm)	43161
QX-4 Accessories	
ø3 mm, Spot	43164
ø5 mm, Spot	43165
ø8 mm, Spot	43166
Connection Cable, 0.5 M Extension	41563
Connection Cable, 1.0 M Extension	41564
Connection Cable, 1.5 M Extension	41565
Connection Cable, 2.0 M Extension	41566

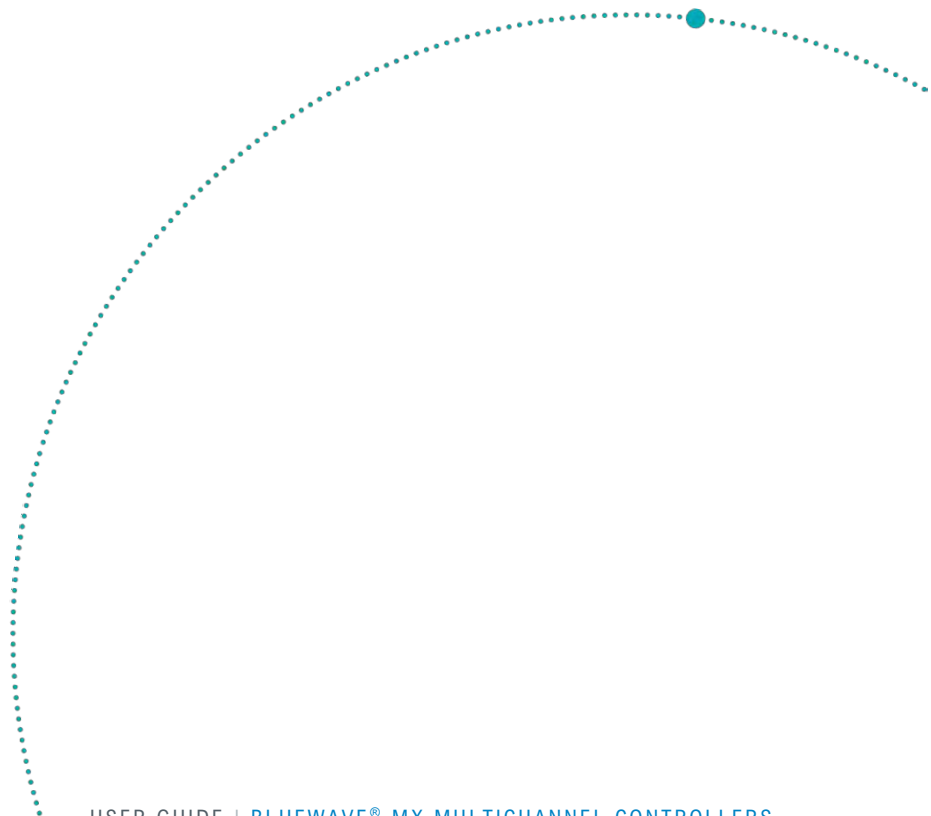

Specifications



Property	Specification
Power Supply Input	100-240V \approx 2.5A, 50-60Hz
LED Timer	0.1 to 999 seconds, max (timer accuracy 0.1%)
LED Activation	Foot pedal, LCD touchscreen, or PLC
Cooling	Convection Air cooled
Controller Dimensions (W x D x H)	5.14" x 7.19" x 7.35" [13.1 cm x 18.3 cm x 18.17 cm]
Weight	Controller: 2.6 lbs. [1.18 kg]
Unit Warranty	1 year from purchase date
Operating Environment	10 to 40°C (50°F to 104°F) 0-80% relative humidity, non-condensing

Figure 37.
Dimensions – Controller

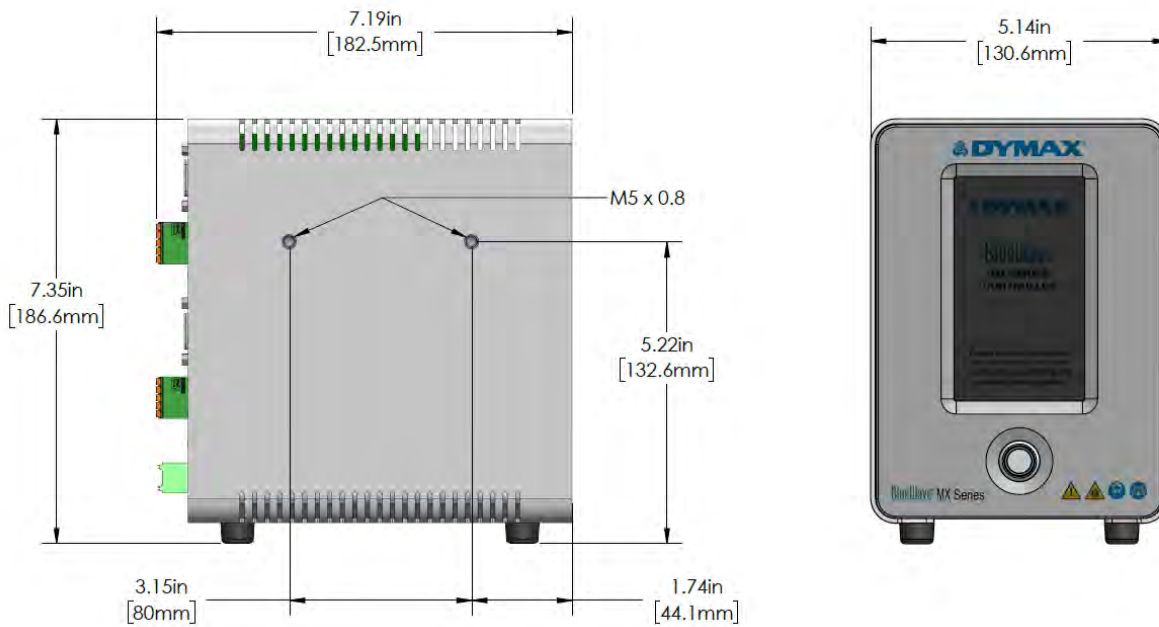

Declaration of Conformity

Figure 38.

Declaration of Conformity - CE



EU Declaration of Conformity

Manufacturer:
Dymax Corporation
318 Industrial Lane
Torrington CT 06790, USA

Product description:
Model name(s):

BlueWave® MX Series System
BlueWave® MX Series Multi Channel Controller

This product complies with the following relevant Union Harmonization Legislation:

Applicable EU Directives:	Applicable Harmonized Standards:
Electromagnetic Compatibility Directive(2014/30/EU)	EN55011:2016/A1:2017/A11:2020 ANSI C63.4-2014
Low Voltage Directive(2014/35/EU)	EN 61010-1:2010, AMD1:2019
RoHS Directive 2011/65 EU (2015/863)	EN IEC 63000:2018

Declaration:
This declaration of conformity is issued under the sole responsibility of the manufacturer.
Signed for and on behalf of:



 6/5/2023 Torrington, CT
Name Date Location

Toby Trudeau
Engineering Manager, Equipment
Dymax Corporation
Torrington CT., USA

North America: +1 860.482.1010 | Europe: +49 611.962.7900 | Asia: +65.67522887

www.dymax.com

© 2021-2022 Dymax Corporation. All rights reserved. All trademarks in this guide, except where noted, are the property of, or used under license by Dymax Corporation, U.S.A.
Please note that most dispensing and curing system applications are unique. Dymax does not warrant the fitness of the product for the intended application. Any warranty applicable to the product, its application and use is strictly limited to that contained in Dymax's standard Conditions of Sale. Dymax recommends that any intended application be evaluated and tested by the user to ensure that desired performance criteria are satisfied. Dymax is willing to assist users in their performance testing and evaluation by offering equipment trial rental and leasing programs to assist in such testing and evaluations. Data sheets are available for valve controllers or pressure pots upon request.

Figure 39.
Declaration of Conformity - UKCA



UK Declaration of Conformity

Manufacturer:
Dymax Corporation
318 Industrial Lane
Torrington CT 06790, USA

Product description: BlueWave® MX Series System
Model name(s): BlueWave® MX Series Multi Channel Controller

This product complies with the following relevant UK Legislation:

<p>Applicable UK Legislation: Electromagnetic Compatibility Regulations 2016</p> <p>Electrical Equipment Safety Regulations 2016</p> <p>The Restriction of the Use of Certain Hazardous Substances in Electrical And Electronic Equipment Regulations 2012</p>	<p>Applicable Harmonized Standards: EN55011:2016/A1:2017/A11:2020 ANSI C63.4-2014 EN 61010-1:2010, AMD1:2019</p> <p>EN IEC 63000:2018</p>
---	--

Declaration:
This declaration of conformity is issued under the sole responsibility of the manufacturer.
Signed for and on behalf of:

 <hr style="width: 100%;"/> <p>Name</p>	<p>6/5/2023</p> <hr style="width: 100%;"/> <p>Date</p>	<p>Torrington, CT</p> <hr style="width: 100%;"/> <p>Location</p>
---	--	--

Authorized Signatory:
Toby Trudeau
Engineering Manager, Equipment
Dymax Corporation
Torrington CT., USA



North America: +1 860.482.1010 | Europe: +49 611.962.7900 | Asia: +65.67522887

© 2021-2022 Dymax Corporation. All rights reserved. All trademarks in this guide, except where noted, are the property of, or used under license by Dymax Corporation, U.S.A.

Please note that most dispensing and curing system applications are unique. Dymax does not warrant the fitness of the product for the intended application. Any warranty applicable to the product, its application and use is strictly limited to that contained in Dymax's standard Conditions of Sale. Dymax recommends that any intended application be evaluated and tested by the user to ensure that desired performance criteria are satisfied. Dymax is willing to assist users in their performance testing and evaluation by offering equipment trial rental and leasing programs to assist in such testing and evaluations. Data sheets are available for valve controllers or pressure pots upon request.



www.dymax.com

Validation

Tests should be conducted prior to production to determine the time and light intensity required to fully cure your resin. The following approaches may be used to validate the curing process.

Set Exposure Time, Determine Intensity

Users can specify a cure time and, through empirical testing, determine the intensity required to achieve a full cure. As with any manufacturing process, it is advisable to incorporate a safety factor.

Set Intensity, Determine Exposure Time

Users can specify light intensity and, through empirical testing, determine the exposure time required to achieve a full cure. As with any manufacturing process, it is advisable to incorporate a safety factor.

NOTE: Dymax recommends intensities low at first to preserve LED life.

Contact the Dymax Application Engineering Team for additional process support.

Control

Process validation confirms a minimum acceptable intensity. Users can then choose to operate at full intensity (using the excess intensity as an additional safety factor) or adjust the output to a specific intensity level. To ensure consistent and repeatable process results, intensity levels should be monitored with a radiometer. This enables users to identify light intensity changes and take corrective action (either adjusting the light intensity or performing maintenance).

Warranty

From date of purchase, Dymax Corporation offers a one-year warranty against defects in material and workmanship on all system components with proof of purchase and purchase date. Unauthorized repair, modification, or improper use of equipment may void your warranty benefits. The use of aftermarket replacement parts not supplied or approved by Dymax Corporation, will void any effective warranties and may result in damage to the equipment.

IMPORTANT NOTE: DYMAX CORPORATION RESERVES THE RIGHT TO INVALIDATE ANY WARRANTIES, EXPRESSED OR IMPLIED, DUE TO ANY REPAIRS PERFORMED OR ATTEMPTED ON DYMAX EQUIPMENT WITHOUT WRITTEN AUTHORIZATION FROM DYMAX. THOSE CORRECTIVE ACTIONS LISTED ABOVE ARE LIMITED TO THIS AUTHORIZATION.

Index

Accessories, 34	UV Exposure, 7
Alarm Codes, 32	Setup, 14
Cleaning, 29	Spare Parts, 34
Contact Information, 5	Specifications, 35
Curing System Safety, 7	Support, 5
Dimensions, 35	System Screens
Help, 5	Cure Delay Screen, 25
Modes of Operation	Curing Time Screen, 25
Manual Mode, 15	Information Screen, 24
PLC, 16	New Password Screen, 29
Timed Mode, 15	PLC Screen, 26
Modes of Operations, 15	Power Level Screen, 25
Operation, 20	Production Screen, 26
Operation	Program Name Screen, 27
MX-Series Multichannel Controller, 32	Program Screen, 26
Optional Equipment, 34	Settings Screen, 27
Parts Included, 14	User Screen, 28
Product Overview, 9	Troubleshooting, 31
Safety, 5	Unpacking, 13
Safety of UV Light	Validation, 35
Bright, Visible Light, 9	Warranty, 37
High-Temperature Surfaces, 8	



North America: +1 860.482.1010 | Europe: +49 611.962.7900 | Asia: +65.67522887

© 2018-2022 Dymax Corporation. All rights reserved. All trademarks in this guide, except where noted, are the property of, or used under license by Dymax Corporation, U.S.A.

Please note that most dispensing and curing system applications are unique. Dymax does not warrant the fitness of the product for the intended application. Any warranty applicable to the product, its application and use is strictly limited to that contained in Dymax's standard Conditions of Sale. Dymax recommends that any intended application be evaluated and tested by the user to ensure that desired performance criteria are satisfied. Dymax is willing to assist users in their performance testing and evaluation by offering equipment trial rental and leasing programs to assist in such testing and evaluations. Data sheets are available for valve controllers or pressure pots upon request. MAN090 3/13/2024