

Model 826 Dispensing Systems

User Guide

Contents

Safety	3
Using Safe Operating Pressures	3
Configuration Overview	3
Key System Connections	5
Dispensing Tips	6
System Configurations	7
A - Systems Using a Cartridge Retainer.....	8
B - Systems Using a Bottle Drop-In Tank.....	10
C - Systems Using a 10-Gallon Pressure Tank	13

Safety

Using Safe Operating Pressures

Pressurizing the components in the dispensing system beyond the maximum recommended pressure can result in the rupturing of components and serious personal injury. To minimize the risk of rupturing components and injury, do not exceed the maximum operating pressure of the components in your fluid dispensing system.

Operating Specifications

- Recommended compressed air supply pressure to air filter/regulator = 80 to 100 psi (5.5 to 6.9 bar)
- Recommended pressure setting at air filter/regulator = 75 psi (5.2 bar)
- Maximum pressure setting at air filter/regulator = 100 psi (6.9 bar)
- Power required = 100-240V, 50-60 Hz power receptacle (customer supplied)

Configuration Overview

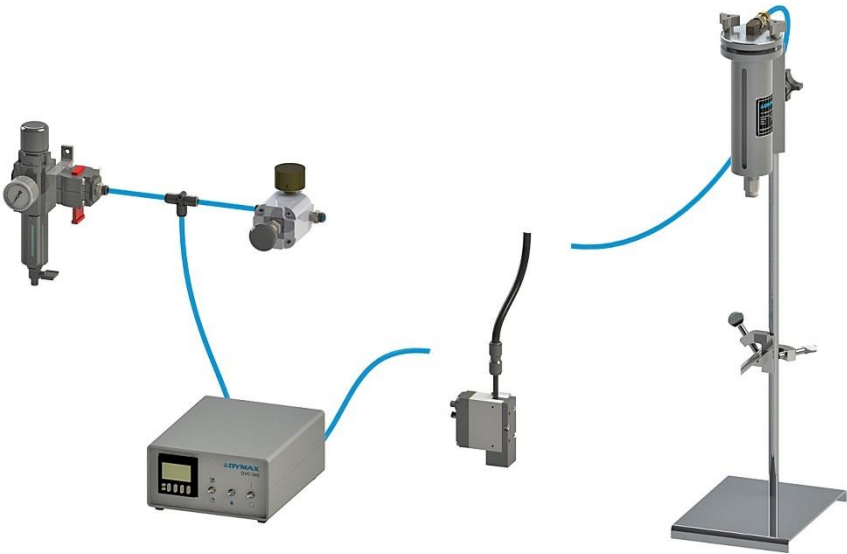

1

Controls

Dymax valves and digital controller provide precise and consistent actuation.

- Pneumatic function
- Footswitch, manual, or PLC controlled
- Easy to operate
- Manual or timed dispense mode

2

Dispensing Valve & Accessories

Dymax dispensing valves for handheld and bench-top applications deliver precision solutions for low- to high- viscosity materials. Various style tips and accessories are also available.

3

Reservoirs

Dymax carries a variety of material reservoirs to accommodate most dispensing applications.

- Range of volumes from 6 oz. cartridges to 10-gallon pressure tanks
- Easy change-over and control

Key System Connections

NOTE: Figures 1-4 apply to all systems.

Figure 1.
Valve Air & Material Connections

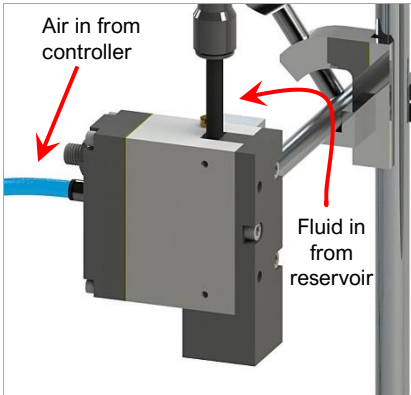

Figure 2.
Controller Connections, Rear Panel

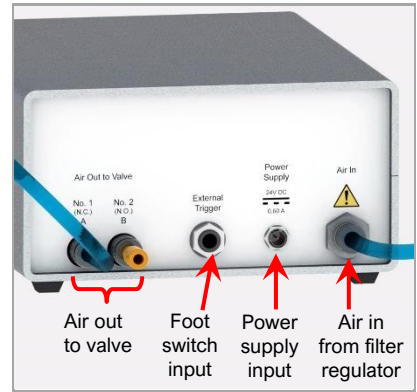

Figure 3.
High-Precision Regulator Connections

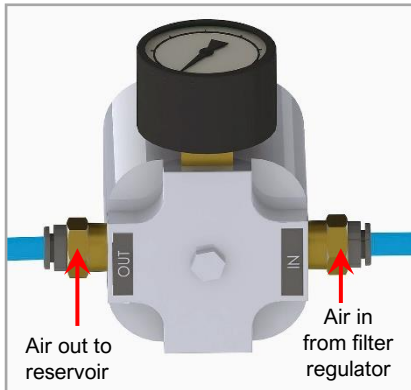
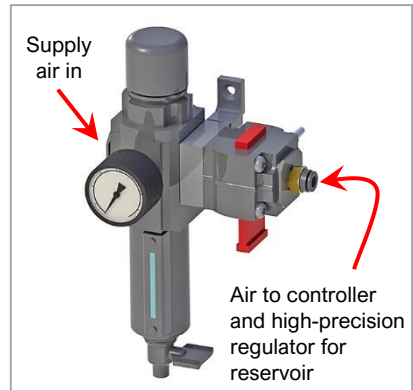

Figure 4.
Filter Regulator







Dispensing Tips





A variety of both needle and taper dispense tips in various lengths, gauges, and shapes are available from Dymax. Tip selection is critical when precision is required and the length, shape, and size of the tip used will define the shape of the fluid deposit and the performance of your dispense system.

The following tips are included with this system and are recommended for use with the Model 826 dispensing valve.

P3424 Dispensing Tip Kit for Low-Viscosity Materials (<500 cP)

Part #	Color	Description	
P3171	Purple	21 GA Needle Tip	
P3172	Orange	23 GA Needle Tip	
P3233	Pink	20 GA Tapered Tip	
P3247	Red	25 GA Tapered Tip	

P3423 Dispensing Tip Kit for Medium- to High-Viscosity Materials (>500 cP)

Part #	Color	Description	
P3169	Amber	15 GA Needle Tip	
P3170	Green	18 GA Needle Tip	
P3232	Green	18 GA Tapered Tip	
P3247	Red	25 GA Tapered Tip	

For assistance in optimal tip selection, contact Dymax Application Engineering. Visit dymax.com to see Dymax's dispensing tip selection.

System Configurations



A

Systems Using a Cartridge Retainer (p. 8-9)

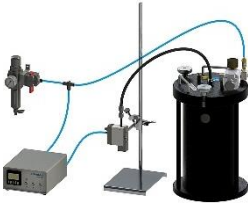

B

Systems Using a Bottle Drop-In Tank (p. 10-12)



C

Systems Using a 10-Gallon Pressure Tank (p. 12-15)

A - Systems Using a Cartridge Retainer

Packaged Components

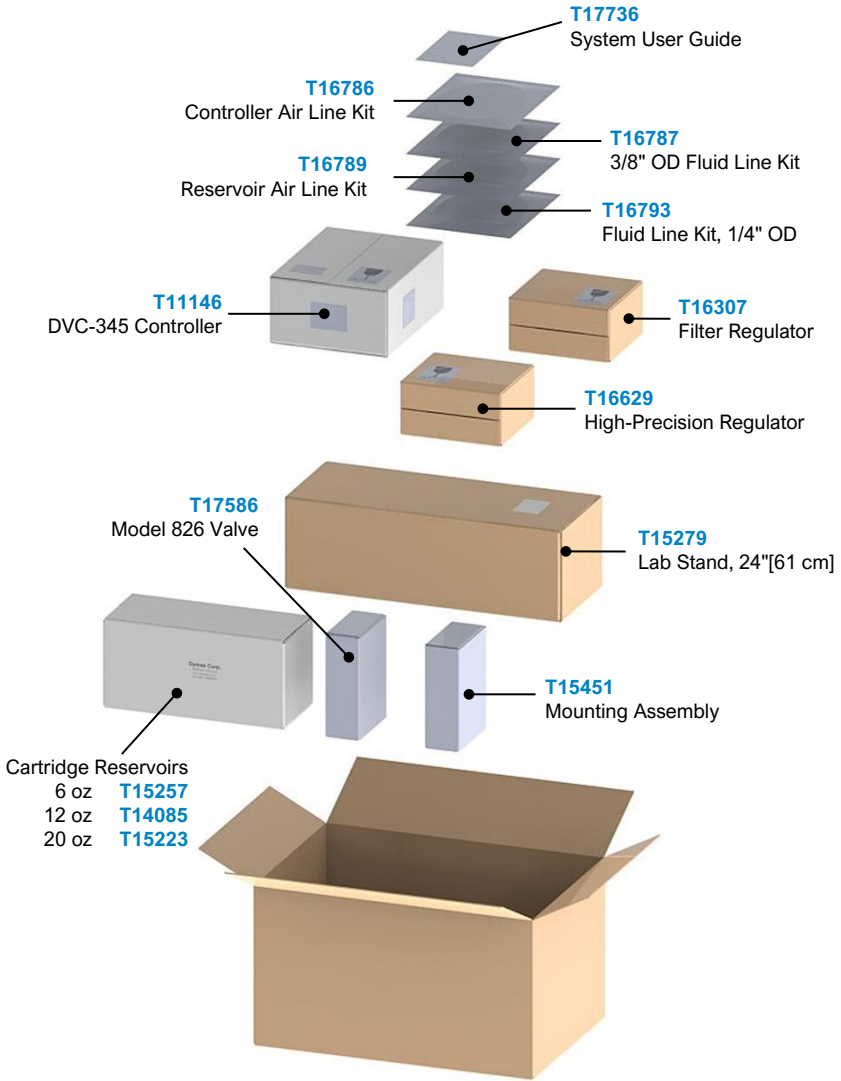

Assembled System

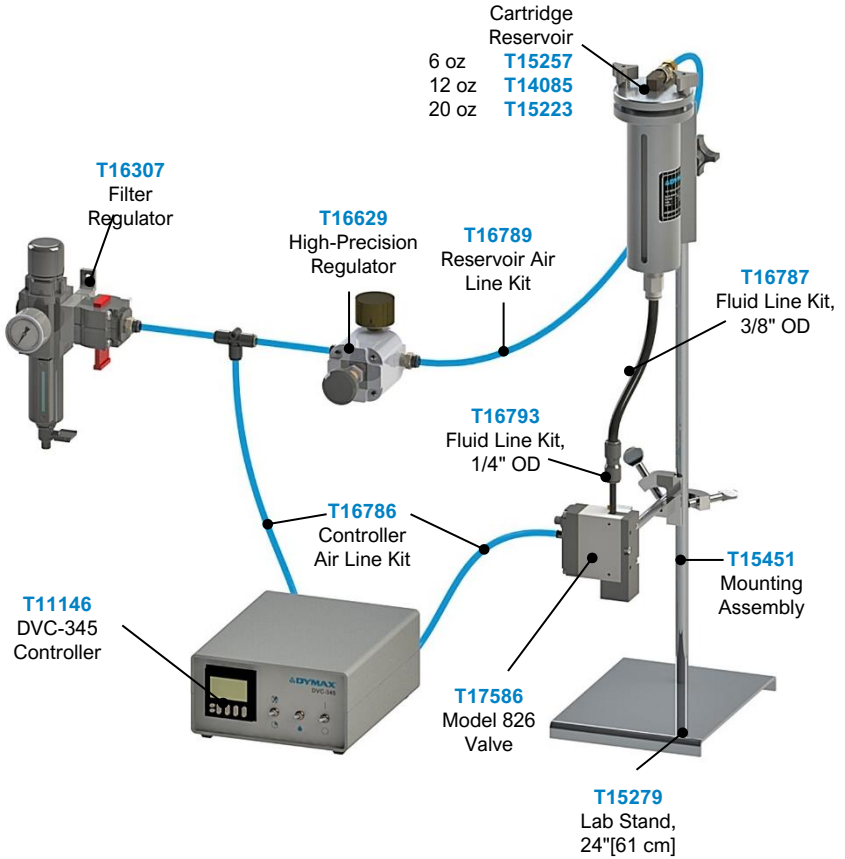

User-Supplied Items	Spare Parts
80-100 psi air supply, 1/4 NPT male fitting	Dispense tips
100-240V power receptacle	Fluid line kits

B - Systems Using a Bottle Drop-In Tank

Packaged Components

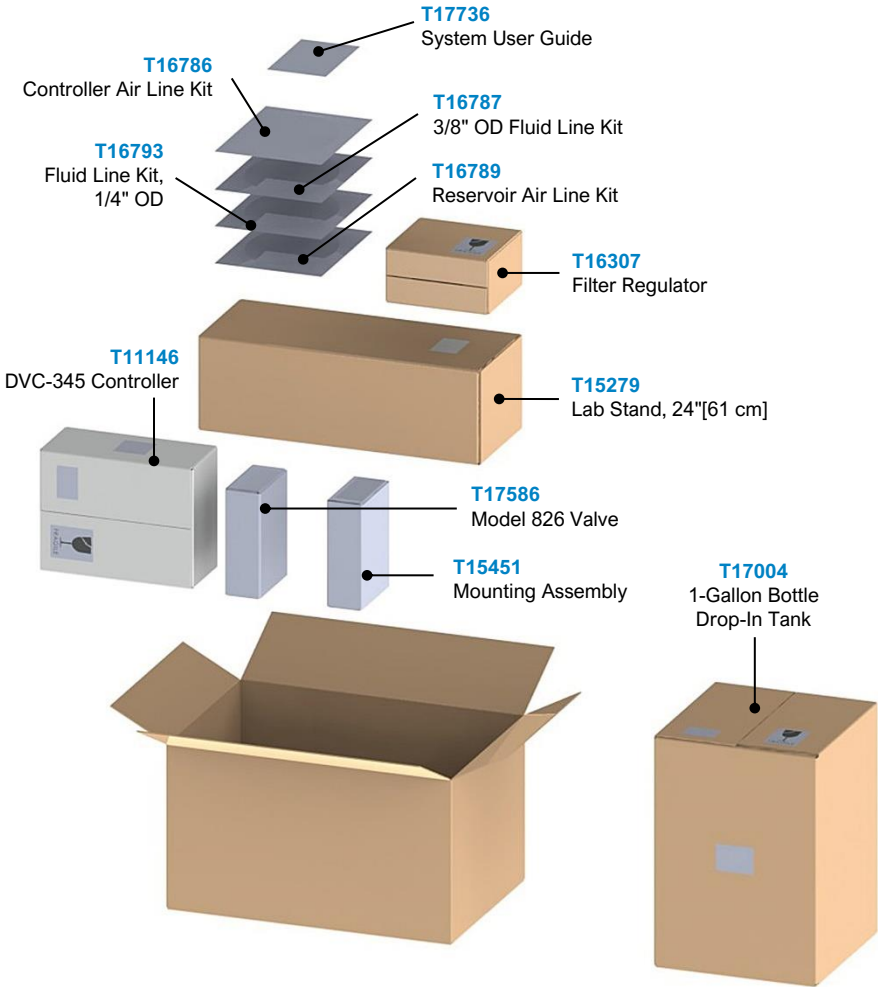

Assembled System

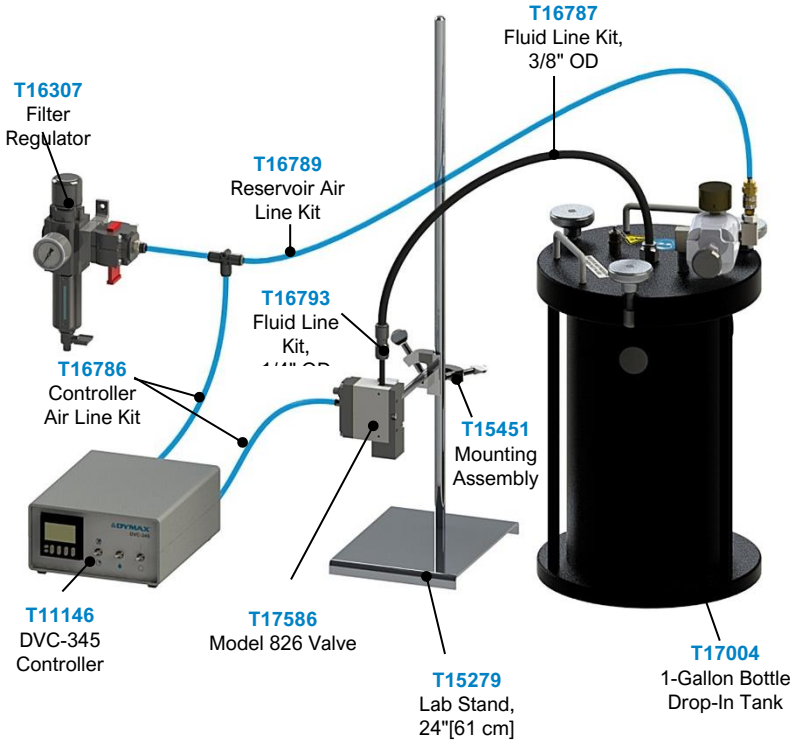

User-Supplied Items	Spare Parts
80-100 psi air supply, ¼ NPT male fitting	Dispense tips
100-240V power receptacle	Fluid line kits

Installing the Fluid Line to the Reservoir

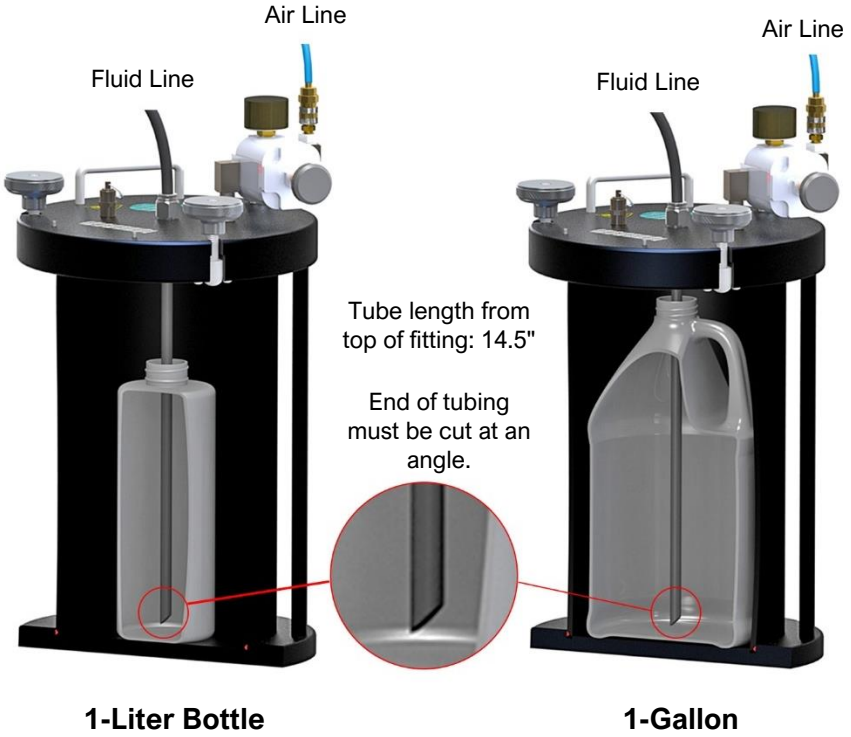

C - Systems Using a 10-Gallon Pressure Tank

Packaged Components

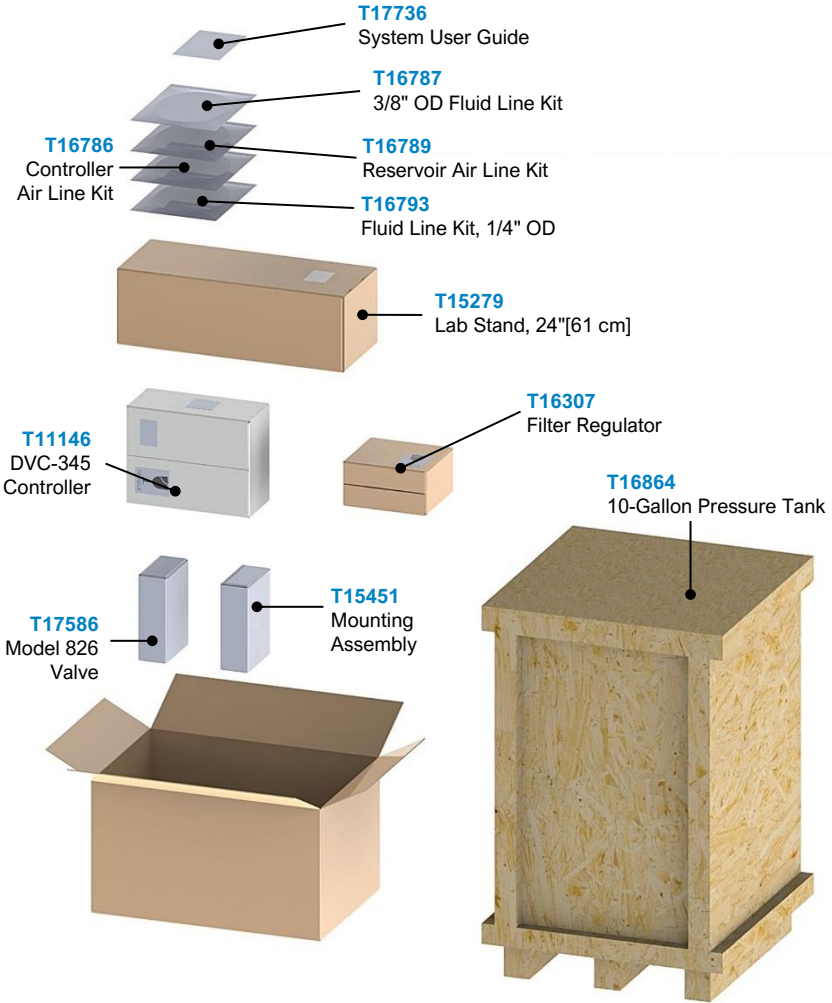

Assembled System

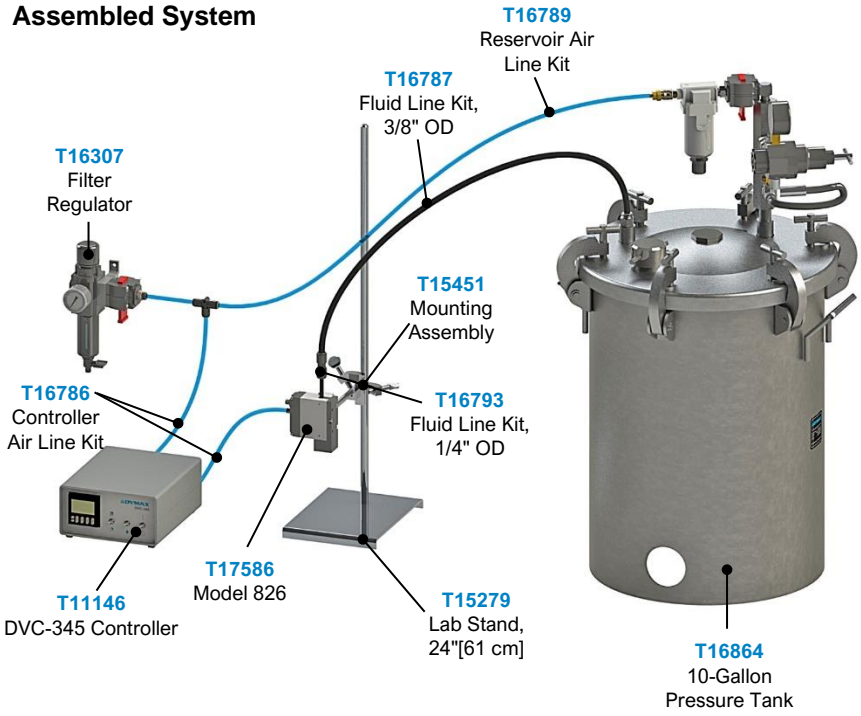

User-Supplied Items	Spare Parts
80-100 psi air supply, ¼ NPT male fitting 100-240V power receptacle	Dispense tips Fluid line kits

Installing the Fluid Line to the Reservoir

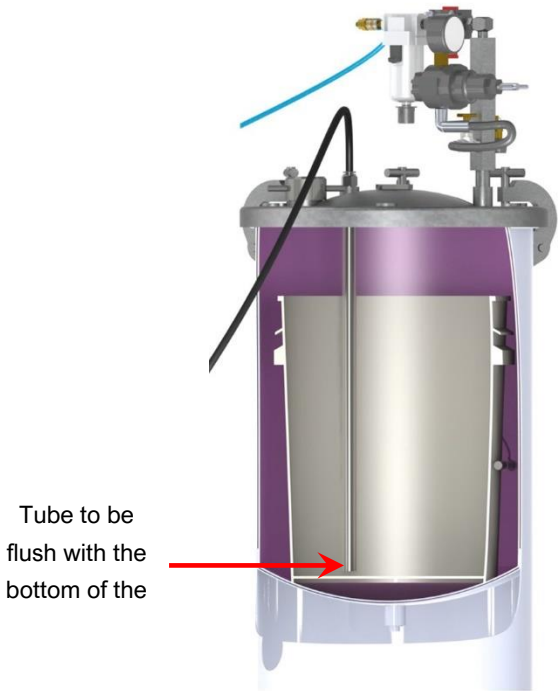

15-Liter Pail



Americas

USA | +1.860.482.1010 | info@dymax.com

Europe

Germany | +49 611.962.7900 | info_de@dymax.com
Ireland | +353 21.237.3016 | info_ie@dymax.com

Asia

Singapore | +65.67522887 | info_ap@dymax.com
Shanghai | +86.21.37285759 | dymaxasia@dymax.com
Shenzhen | +86.755.83485759 | dymaxasia@dymax.com
Hong Kong | +852.2460.7038 | dymaxasia@dymax.com
Korea | +82.31.608.3434 | info_kr@dymax.com

© 2014 Dymax Corporation. All rights reserved. All trademarks in this guide, except where noted, are the property of, or used under license by Dymax Corporation, U.S.A.

Please note that most dispensing system applications are unique. Dymax does not warrant the fitness of the product for the intended application. Any warranty applicable to the product, its application and use is strictly limited to that contained in Dymax standard Conditions of Sale published on our website. Dymax recommends that any intended application be evaluated and tested by the user to ensure that desired performance criteria are satisfied. Dymax is willing to assist users in their performance testing and evaluation. Data sheets are available for valve controllers or pressure pots upon request. MAN064 T17804 12/19/2014