

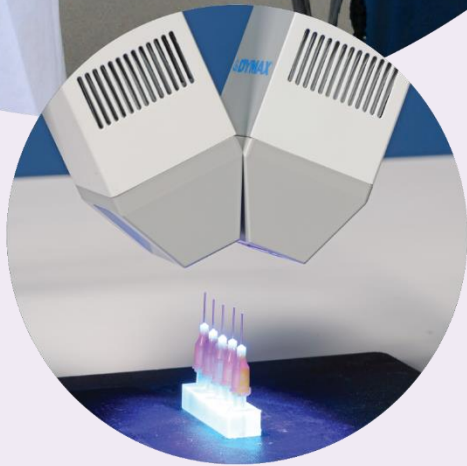
System Discontinued 3/1/2021

CE



## BlueWave<sup>®</sup> AX-550

Compact, Large-Area LED  
Flood System User Guide



## About Dymax

UV/Visible light-curable adhesives. Systems for light curing, fluid dispensing, and fluid packaging.

Dymax manufactures industrial, light-curable, epoxy, and activator-cured adhesives. We also manufacture a complete line of manual fluid dispensing systems, automatic fluid dispensing systems, and light-curing systems. Light-curing systems include LED light sources, spot, flood, and conveyor systems designed for compatibility and high performance with Dymax adhesives.

Dymax adhesives and light-curing systems optimize the speed of automated assembly, allow for 100% in-line inspection, and increase throughput. System designs enable stand-alone configuration or integration into your existing assembly line.

Please note that most dispensing and curing system applications are unique. Dymax does not warrant the fitness of the product for the intended application. Any warranty applicable to the product, its application, and use is strictly limited to that contained in the Dymax standard Conditions of Sale. Dymax recommends that any intended application be evaluated and tested by the user to ensure that desired performance criteria are satisfied. Dymax is willing to assist users in their performance testing and evaluation by offering equipment trial rental and leasing programs to assist in such testing and evaluations. Data sheets are available for valve controllers or pressure pots upon request.

# Contents

<b>Introduction</b> .....	<b>4</b>
Intended Audience .....	4
Where to Get Help.....	4
<b>Safety</b> .....	<b>4</b>
<b>Product Overview</b> .....	<b>5</b>
System Description .....	5
<b>Unpacking</b> .....	<b>6</b>
Unpacking and Inspecting Your Shipment .....	6
Parts Included .....	6
<b>System Installation</b> .....	<b>7</b>
System Assembly .....	7
System Cooling .....	7
Wiring and Connections .....	8
Connections .....	9
<b>PLC UV Control</b> .....	<b>12</b>
Status Output .....	13
<b>Operation</b> .....	<b>15</b>
Rotary Push Button .....	15
System Initializing.....	15
System Settings.....	17
Irradiation Setup .....	21
Irradiation in Production or Admin Mode .....	24
Irradiation in PLC mode.....	25
<b>Maintenance</b> .....	<b>26</b>
Product Cleaning.....	26
Emitter Replacement.....	26
Replace Fuse .....	27
<b>Troubleshooting</b> .....	<b>28</b>
Error Screen.....	28
<b>Workplace Safety Testing</b> .....	<b>30</b>
<b>Spare Parts &amp; Accessories</b> .....	<b>30</b>
Accessories.....	30
Components & Spare Parts .....	30
<b>Specifications</b> .....	<b>31</b>
<b>Validation</b> .....	<b>33</b>
Set Exposure Time, Determine Intensity .....	33
Set Intensity, Determine Exposure Time .....	33
Control .....	33
<b>Warranty</b> .....	<b>33</b>

# Introduction

This guide describes how to set up, use, and maintain BlueWave® AX-550 LED flood-curing system safely and efficiently.

## Intended Audience

This user guide is meant for experienced process engineers, technicians, and manufacturing personnel. If you are new to high-intensity LED light sources and do not understand the instructions, contact Dymax Application Engineering for answers to your questions before using the equipment.

## Where to Get Help

Dymax Customer Support and Application Engineering teams are available by phone in the United States, Monday through Friday, from 8:00 a.m. to 5:30 p.m. Eastern Standard Time. You can also email Dymax at [info@dymax.com](mailto:info@dymax.com). Contact information for additional Dymax locations can be found on the back cover of this user guide.

Additional resources are available to ensure a trouble-free experience with our products:

- Detailed product information on our website [www.dymax.com](http://www.dymax.com)
- Dymax adhesive product data sheets on our website
- Safety data sheets (SDS) provided with shipments of Dymax materials

## Safety



**WARNING!** *If you use this UV light source without first reading and understanding the information in the UV Light Safety Guide, SAF001, injury can result from exposure to high-intensity light. To reduce the risk of injury, please read and ensure you understand the information in that guide before assembling and operating the Dymax UV LED light source.*

*This device falls under IEC 62471 Risk Group 3 for UVA and Blue Light emissions:*

**WARNING!** *UV emitted from this product. Avoid eye and skin exposure to unshielded products.*

**WARNING!** *Possibly hazardous optical radiation emitted from this product. Do not look at operating lamp. Eye injury may result.*

# Product Overview

## System Description

The BlueWave AX-550 is a high-intensity LED flood system used for curing light-curable materials. The unit is designed to be integrated into a larger system, such as an automated manufacturing system, or used with a light shielding enclosure to create a bench-top curing station.

The BlueWave AX-550 is a single component system that incorporates an LED flood emitter and control system for manual and automated process applications. Dymax offers three different wavelength LED flood emitters: VisiCure® (405 nm), PrimeCure® (385 nm), and RediCure® (365 nm).

The controller portion includes the controller and power supply, which is designed to identify the type of emitter that is connected so the control portion of the system can be used with any of the three LED emitter configurations.

The BlueWave AX-550 functions as a flood-curing system with a 125 mm x 125 mm (5 in x 5 in) irradiated curing area.

The unit can be operated in admin mode (unrestricted control) or production mode (restricted control) which allows for process management via access restrictions.

The unit can be controlled as well by Programmable Logic Controller (PLC) for automation applications.

LED technology within the BlueWave AX-550 LED Flood System allows for instant on/off activation without the need for a warm-up period but is also rated for continuous operation.

Fans in the emitter provide cooling air flow. The vents on the top and side of the system must not be covered or blocked, refer to the section “System Cooling” for details.

There are thermal sensors in the controller and emitter to protect the system if the internal temperature exceeds maximum limits.

**Figure 1.**  
AX-550 LED Flood Curing System



# Unpacking

## Unpacking and Inspecting Your Shipment

Upon arrival, inspect all boxes for damage and notify the shipper of box damage immediately. Open each box and check for equipment damage. If parts are damaged, notify the shipper and submit a claim for the damaged parts. Contact Dymax so that new parts can be shipped to you immediately.

The parts below are included in every package/order. If parts are missing from your order, contact your local Dymax representative or Dymax Customer Support to resolve the problem.

Inspect the glass for any damage or residue on the surface. Carefully clean the glass with the alcohol swab. Take care not to touch the glass with bare hands, as any residue left on the window can adversely affect performance on the unit.

### Parts Included

- BlueWave AX-550 Controller
- BlueWave AX-550 Emitter (RediCure, PrimeCure, or VisiCure, model as selected at time of purchase)
- Power Cord
- BlueWave AX-550 LED Flood System User Guide (document not shown)
- Terminal Block (Plugged on the BlueWave AX-550 Controller)
- Foot Pedal
- Safety Eyewear

**Figure 2.**  
System Packaging



**Figure 3.**  
Components of the BlueWave AX-550 Curing System



# System Installation

## System Assembly

The system includes two major parts, the Controller and the Emitter. The two parts are shipped separately. To assemble the two parts together, please follow the instruction below:

1. Locate the 4 Screws to be used to assemble the Emitter to the Controller.
2. Carefully place the Emitter on a clean and flat surface. Align the Controller and the Emitter as shown in Figure 4. Plug the Controller into the Emitter.

*Note: Be careful to keep the glass at the bottom of the Emitter clean. To avoid leaving fingerprints on the glass, do not touch the glass with bare hands.*

3. Install the 4 Screws to secure the Emitter to the Controller.

## System Cooling

The system can be used in various scenarios with additional mounting fixtures or Dymax accessories. For example: on a desktop with a Dymax stand, on a chamber, conveyer, etc. This system should only be operated in a location that provides proper cooling. Location requirements are as follows:

- For proper cooling of the unit, upper intake and lower exhaust must not be blocked.
- Minimum clearance as shown in Figure 6.

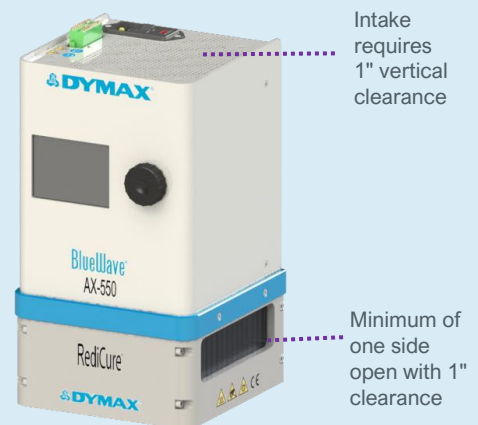
**Figure 4.**  
Align Controller and Emitter



**Figure 5.**  
Install 4 Screws



**Figure 6.**  
Minimum Clearance



## Wiring and Connections

All the wire and cable connections are at the top side of the controller.

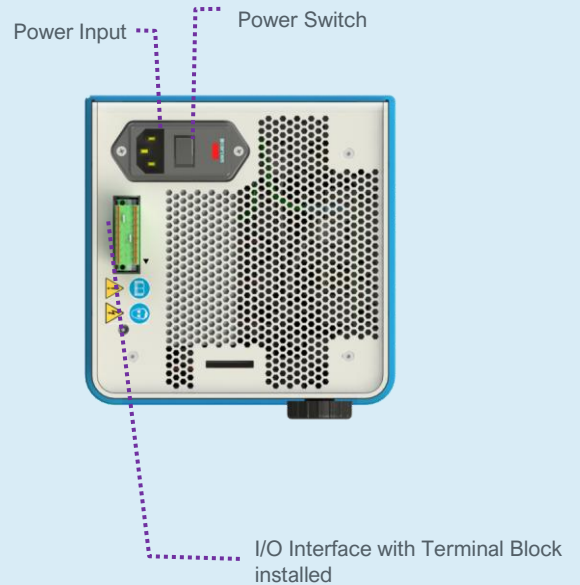
**Power Input:** The power cord plugs in here.

**Power Switch:** Turns the unit on and off.

**I/O Interface:** Reference connector pin-out on the back of the controller ().


**PLC Connector:** Terminal block for all wiring of remote-control features including foot pedal, inhibit/interlock, PLC and status display.

**Figure 7.**  
Controller, Topside



**Figure 8.**  
PLC Connector Pin Reference



FUSE			
 F 10 A 250 VAC ~100-240 VAC 50/60 Hz 10 A			
PLC CONNECTOR			
▲ SPARE	1	9	SPARE
SPARE	2	10	SYSTEM HEALTH
ANALOG INTENSITY	3	11	LED STATE
PLC GND	4	12	PLC ENABLE
MASTER INTERLOCK	5	13	TRIGGER COM
LED ON/OFF	6	14	TRIGGER
INTENSITY INT/EXT	7	15	LED INHIBIT
PLC PWR	8	16	COM
COM	A	B	COM

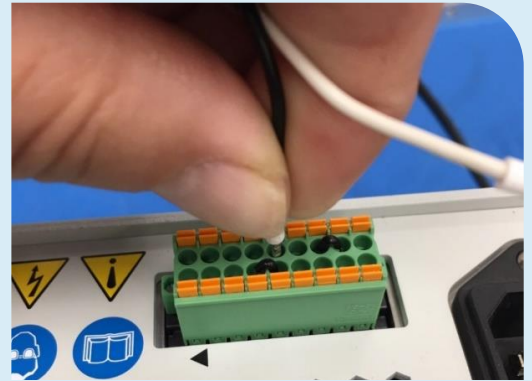


## Connections

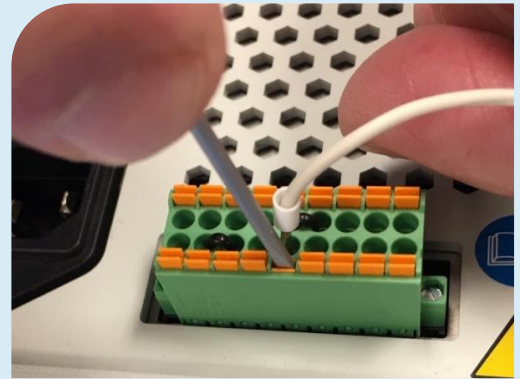
An 18-pin removable terminal block (the green part in the photos below) comes with the controller. The terminal block allows quick and easy wiring. The terminal block can fit the wire from AWG 24 to AWG 16.

- **To connect a hard wire to the terminal block** (such as the foot pedal terminals): Plug the end of the wire into the terminal (Figure 9).
- **To connect a soft wire to the terminal block or pull out the wire from the terminal block**: Use a flat screwdriver to push the orange tab located beside the terminal. Then plug the wire in or pull the wire out (Figure 10).
- **To remove the jumper from the terminal block**: Use two flat screw drivers to simultaneously push the orange tabs located beside the terminal. Then pull the jumper out. (Figure 11)

**Figure 9.**  
Insert Hard Wire into Terminal Block



**Figure 10.**  
Insert Soft Wire or Pull Wire Out of Terminal Block



**Figure 11.**  
Remove Jumper from Terminal Block



## I/O Interface Summary

Table 1 below shows the summary of all signals on the PLC Connector.

**Table 1.**  
I/O Interface

Signal Name / Description	PIN #	Signal Level	
		Asserted	De-Asserted
<b>INPUTS</b>			
SPARE(S)	1, 2, 9	Do Not Use	
ANALOG INTENSITY Only used in PLC – EXT mode Sets Emitter intensity level (0~1V=10% output, 10V=100% output) Input Impedance: 10KΩ	3	0 – 10 VDC	N/A
MASTER INTERLOCK Input Current: 0 – 7mA	5	0 VDC, GND	(Open)
PLC ENABLE Input Current: 0 – 7mA	12	0 VDC, GND	(Open)
LED ON/OFF Input Current: 0 – 7mA	6	0 VDC, GND	(Open)
INTENSITY INT/EXT (Internal/External control) Input Current: 0 – 7mA	7	0 VDC, GND	(Open)
LED INHIBIT Input Current: 0 – 7mA	15	0 VDC, GND	(Open)
TRIGGER Switch Input: Open and Close Close Current: 7mA	14	Shorted to PIN 13	(Open)
<b>OUTPUTS</b>			
PLC POWER (1) (24V, 500mA maximum)	8	Always On	
SYSTEM HEALTH Sink Current: 50mA max.	10	0 VDC, GND	Open
LED STATE Sink Current: 50mA max.	11	0 VDC, GND	Open
<b>RETURNS (These pins are common and may be used interchangeably)</b>			
PLC GND (Common signal return)	4	PLC mode Ground	
COM (Common signal returns)	A, B, 16	Common Grounds	
TRIGGER COM (Common signal return)	13	Shorted to PIN 14	(Open)

(1) PLC power channel is a 24V source available for use to drive PLC logic but must be current limited using pull-down resistors to protect the BlueWave AX-550 when directly attached to the I/O channels through the PLC connector.

## Connect Power Cord

1. Attach the Power Cord to the Power Input located on the unit's top panel ( ).
2. Plug the opposite end of the Power Cord into an appropriate AC outlet. The system uses universal 100 ~ 240 VAC power.

**WARNING!** If the BlueWave AX-550 controller is powered on without an LED emitter connected, the controller screen will show an alert notification and audible alarm.

## Connect the Inhibit/Interlock PLC Controls

There are 2 control inputs to disable the UV output. These 2 signals must be connected to PLC GND or COM to enable proper operation of the system. The factory supplied I/O connector has jumpers installed for basic operation.

The LED INHIBIT is used to disable the UV output at the emitter head when the jumper or circuit attached is open.

LED INHIBIT is controlled by connecting Pins 15 and 16 on the PLC terminal block.

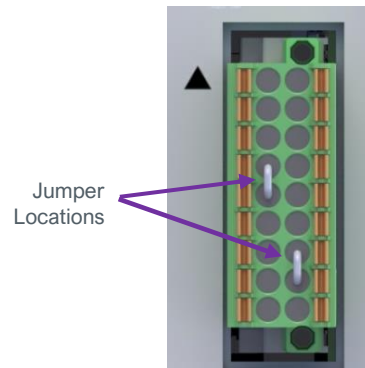
The MASTER INTERLOCK is used to disable the UV output at the controller when the jumper or circuit attached is open.

MASTER INTERLOCK is controlled by connecting Pins 4 and 5.

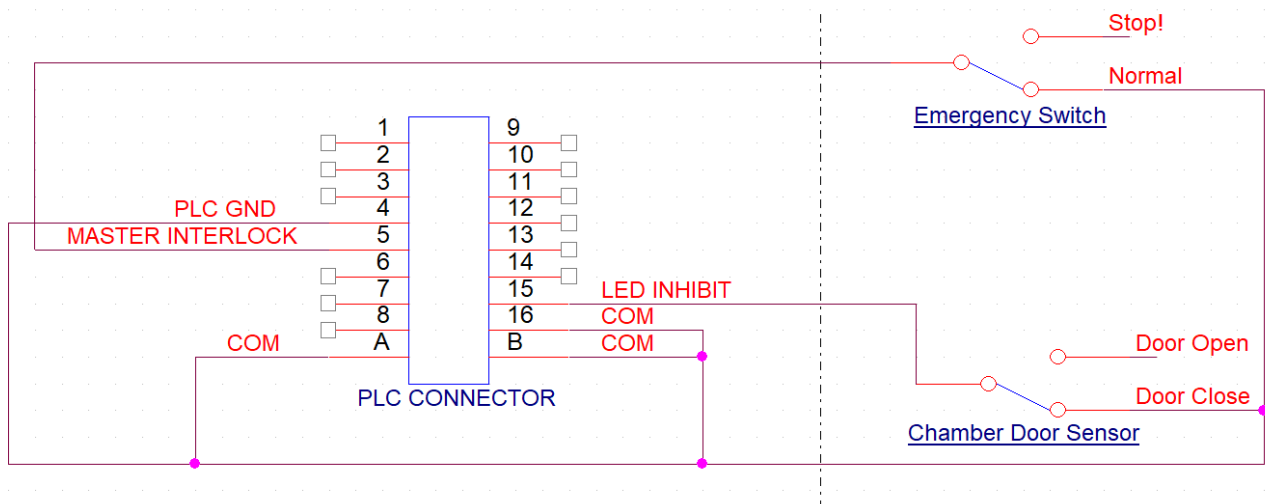
See Figure 12 for the jumper and

Figure 13 for the example connection.

**Figure 12.**  
Factory Jumpers on the PLC Connector,  
Viewed from Backside



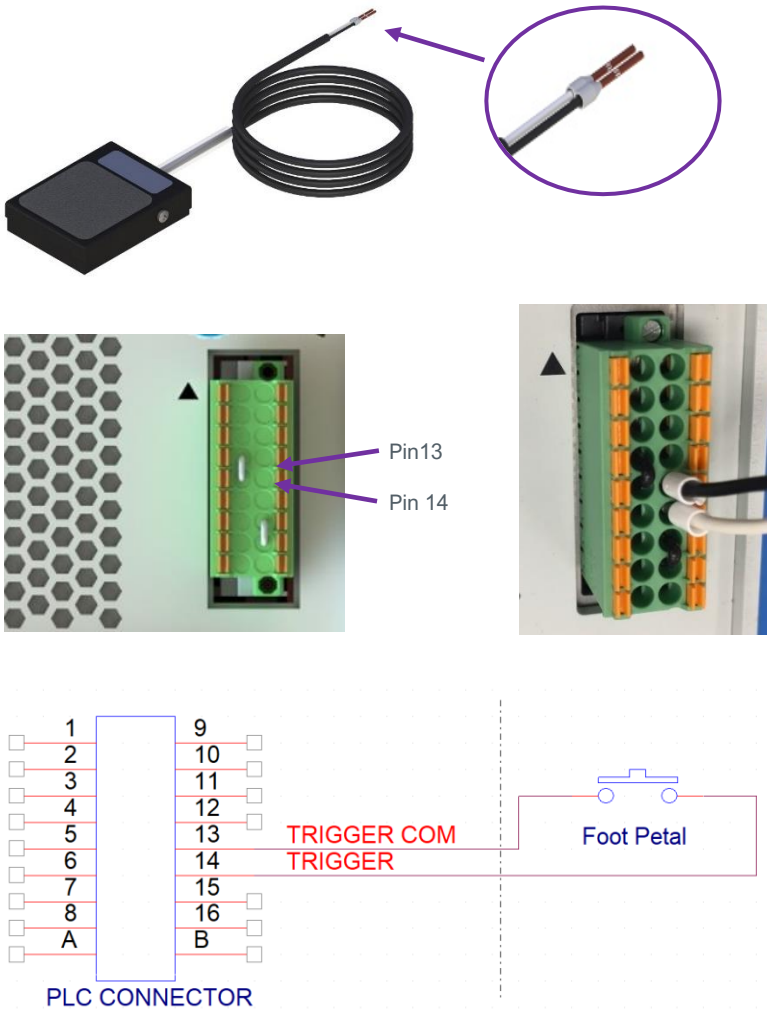
**Figure 13.**  
Example Connection for LED INHIBIT and MASTER INTERLOCK



## Connect Foot Pedal

The system's UV can be turned off/off using the rotary push button on the front of the unit or with an optional foot pedal. If using the foot pedal, connect the TRIGGER and TRIGGER COM pins (PIN 13 & PIN 14) on the PLC Connector. The pins will lock in place when inserted.

**Figure 14.**  
Foot Pedal Connection



## PLC UV Control

PLC switching may be driven by manual switch, relay, or optical coupler. Only analog intensity uses a voltage input to the PLC.

To use the PLC mode inputs, the **PLC ENABLE** pin 12 must be pulled down to low by grounding to the PLC return, **PLC GND** or a **COM** ground point

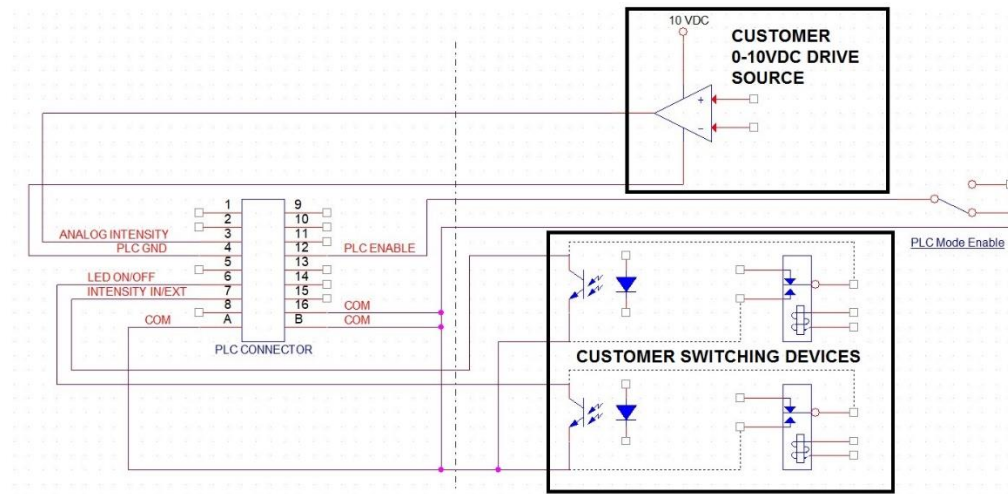
The PLC can control the UV on/off using the **LED ON/OFF** input Pin 6. When this input is pull down by grounding to **COM** ground, the UV LED will turn on.

The PLC can also control the intensity of the UV output.

- When the **INTENSITY IN/EXT** input Pin 7 is pull down to low by grounding to **COM** ground, the Intensity will be controlled by the **EXTERNAL ANALOG INTENSITY** input voltage.
- The **ANALOG INTENSITY** input, Pin 3, is an analog voltage input. The voltage range is 0 to 10VDC.

Any setting 1 VDC or below will set the Intensity to 10% and each additional volt increases intensity by 10%. (Example: 5V = 50%, 7.5V = 75%, 10V = 100%) All three PLC inputs, **LED ON/OFF**, **INTENSITY IN/EXT** and **ANALOG INTENSITY** work in PLC mode only. They are ignored in other working modes. The example connection for the PLC control signal is shown in Figure 15.

**Figure 15.**  
PLC Connection



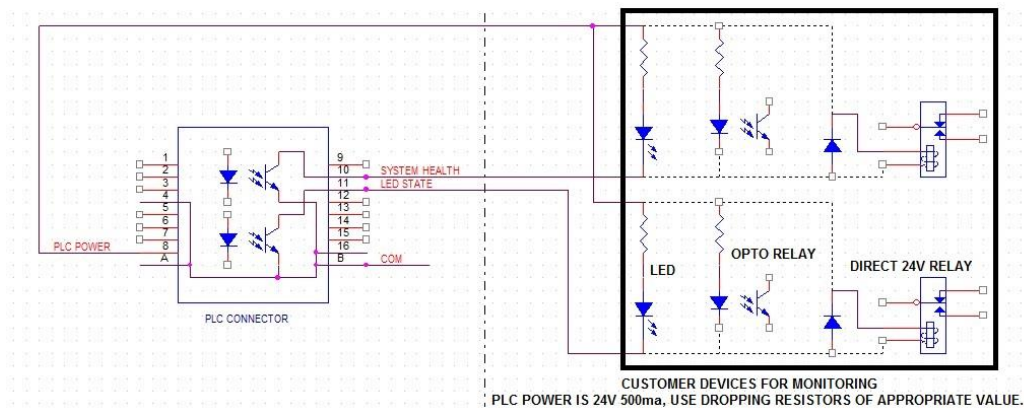
## Status Output

There are two status outputs. They are driven by optical coupler. These outputs work in any mode, can be used as status inputs for PLC or any status display/monitor purpose.

- **System Health** - Output low to indicate the unit is normally working.
- **LED State** - Output low to indicate the UV LEDs are ON.

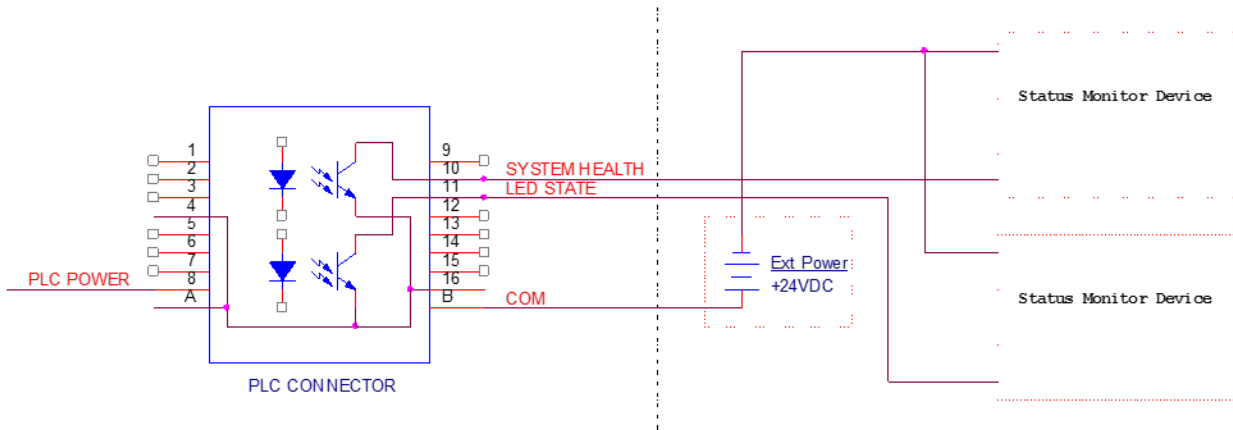
The example application of these signals is shown below in Figure 16.

**Figure 16.**  
Status Outputs Connection Using On-Board 24V Source



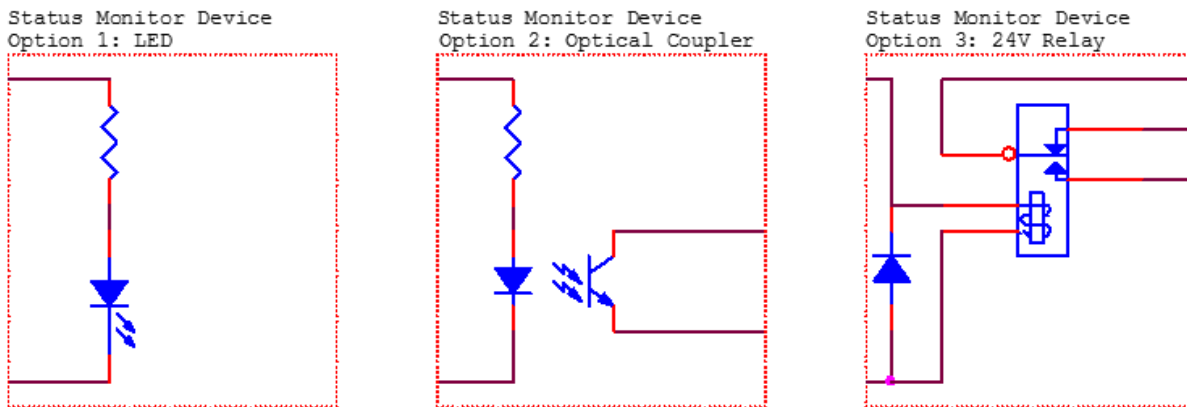
PLC Power channel is a 24V source available for use to drive PLC logic but must be current limited using pull-down resistors to protect the BlueWave AX-550 when directly attached to the I/O channels through the PLC connector.

**Figure 17.**  
 PLC Status Outputs Using Customer-Supplied 24V Source



For sinking current below 7mA it is suggested when using solid state relays to use one of these devices:  
 Weidmuller 8820710000, Phoenix Contact 2980636

**Figure 18.**  
 Examples of Customer Configurations for Monitoring Outputs



# Operation

To operate the BlueWave AX-550 system:

1. Verify that the Controller and Emitter are assembled properly, the input power is correctly plugged into the AC Inlet on the top of the unit, and the Interlock Jumpers (or external safety sensor) are installed between Pins 4 & 5, and 15 & 16 of the I/O Connector on the top of the unit.
2. When all connections are properly made, toggle the Power Switch on the top of the unit. The system is now ready for use.

## Rotary Push Button

### The front panel on the controller (

Figure 19) features a rotary push button for function selection and programming and a color LCD display where settings and status can be viewed and selected.

- Turning the rotary push button moves the selection field as indicated on the LCD display.
- Pressing the center of the rotary push button selects the menu item or sets the input for the active field.

**Note:** The selected value will appear in blue color, when selected value requires modification press the rotary pushbutton, then, this value will turn yellow indicating it is ready to be modified. Turning the rotary pushbutton changes the value to be selected.

## System Initializing

Upon startup of the unit, a splash screen displays the controller and emitter FW versions. After about 6 seconds, the control screen should appear in the display. The unit loads in administrator mode the first time it's started.

The control screen is used to set up and run curing cycles. Admin screen allows users to switch back and forth between admin/production mode if the PLC mode is disabled. Curing parameters are set in the admin screen.

Figure 19.  
Front Panel

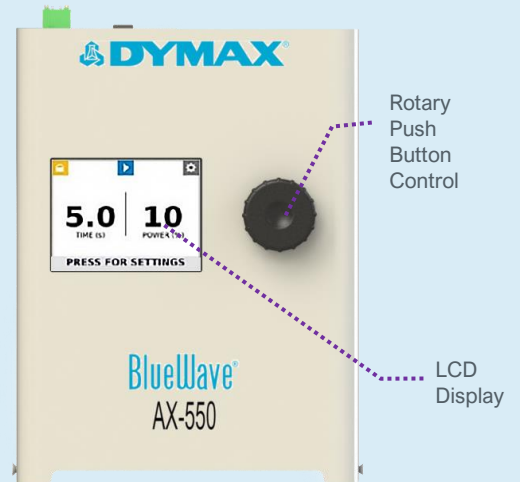


Figure 20.  
Set and Modify a New Value



Figure 21.  
Initializing Screen



The unit was designed to work in three modes of operations as indicated in on the upper left of the display:



**Admin Mode:** The administration mode allows full control of system functions.



**Production Mode:** This mode doesn't allow changes to the irradiation parameters.



**PLC Mode:** in PLC mode, an external PLC can control the unit.

To enter PLC mode, connect the external PLC system and toggle the **PLC ENABLE** input to Low. The PLC icon will be seen on the screen automatically. Leave the PLC ENABLE open to enter the Administrator or Production mode.

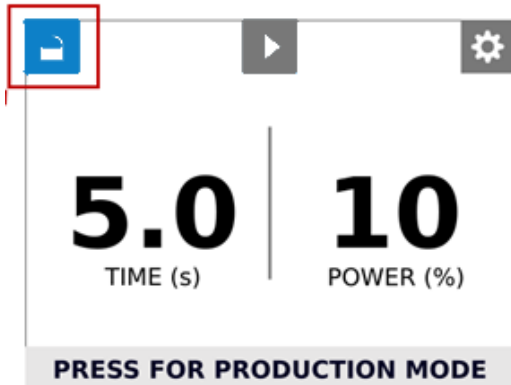
Selecting the padlock button switches between Administration and Production modes, a password will be required to enter admin mode.

The default password to enter admin mode is **00000**. To change the password, please see "System Settings" and Figure 27.

**NOTE:** Switching between PLC and non-PLC mode can happen when the system is powered ON or OFF, but the LED must be OFF for safety.

**Figure 22.**

Padlock location





## System Settings

In Admin Mode or Production Mode, select the settings icon located at the upper right corner.



**Settings:** Loads the settings screen where the volume, language, screen brightness, and other user settings can be adjusted.

In admin mode, the settings screen shows all settings (

Figure 23). In the production mode, the settings screen layout is identical to the admin screen, except the admin settings option is not available (Figure 24).

### Settings Screen



**Language** - Future support for multiple languages.



**Brightness** - Opens the brightness screen where the adjustment of the LCD backlight can be modified in a range from 1 to 10.



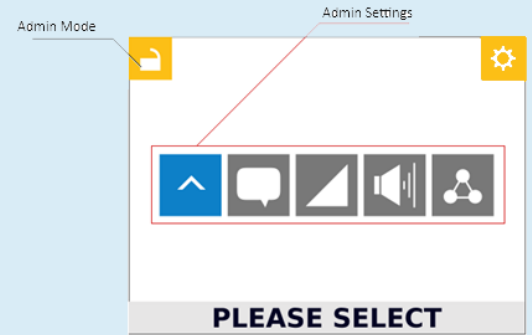
**Volume** - Opens the volume screen where the operation volume can be modified in a range from 0 to 10



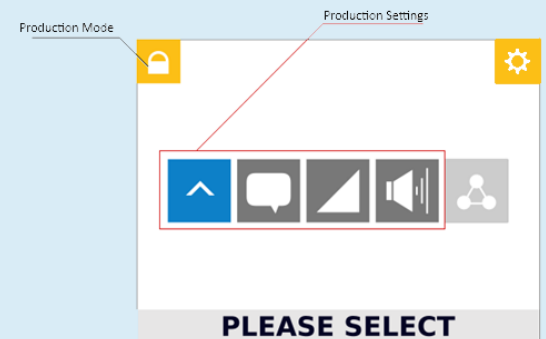
**Admin** - While in Admin mode opens the user screen where boot mode can be selected and the Admin password may be accessed.

The settings and operations for both Admin and Production Mode are shown below:

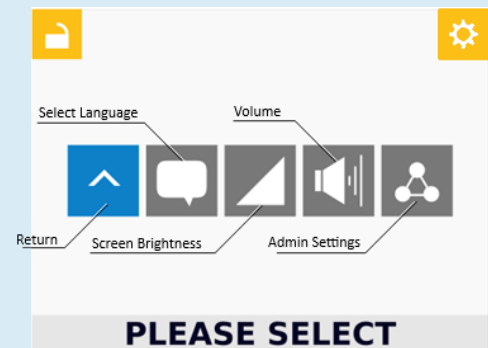
**Figure 23.**  
Admin Mode Settings Screen





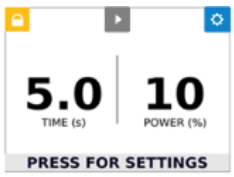









**Figure 24.**  
Production Mode Setting Screen



**Figure 25.**  
Configuration Settings

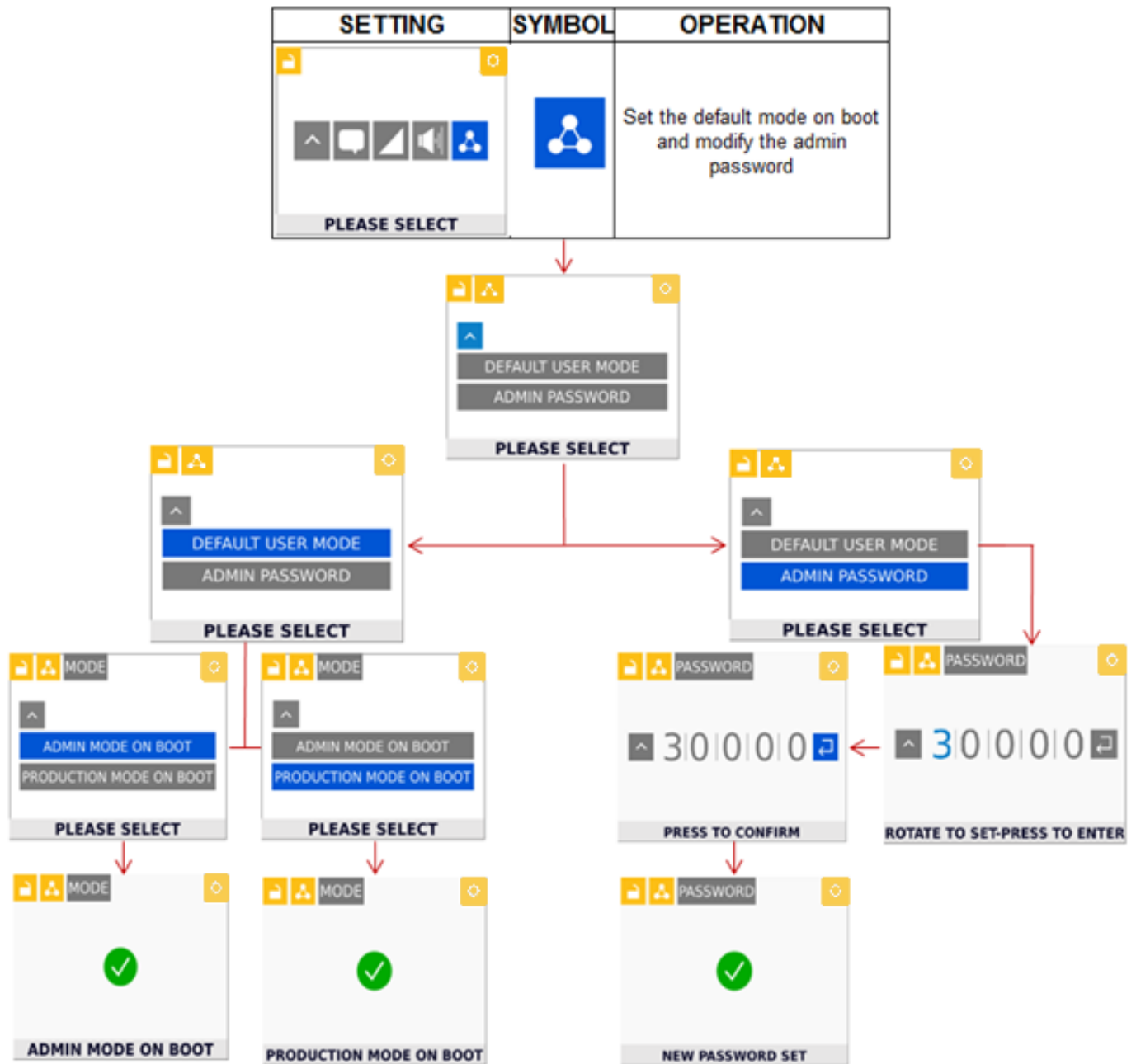


**Table 2.**  
Production and Admin Settings Menu

Setting	Symbol	Operation	Operation Result
		Press the rotary push button when it turns blue to return to the previous menu or to ignore the changes made and keep the current value	
		Used to change the language (only English is available at this time)	
		Opens the brightness screen where the adjustment of the LCD backlight can be modified in a range from 1 to 10, 1 to get the lowest luminosity and 10 the highest luminosity	
		Used to change the operation volume in a range from 0 to 10, 0 to get the mute mode and 10 the highest volume	

The settings and operations for Admin Mode only are shown below:

**Figure 26.**  
Admin Only Settings



### Default User Mode Screen

**ADMIN ON BOOT** - Controller enters Admin mode immediately after power-up.

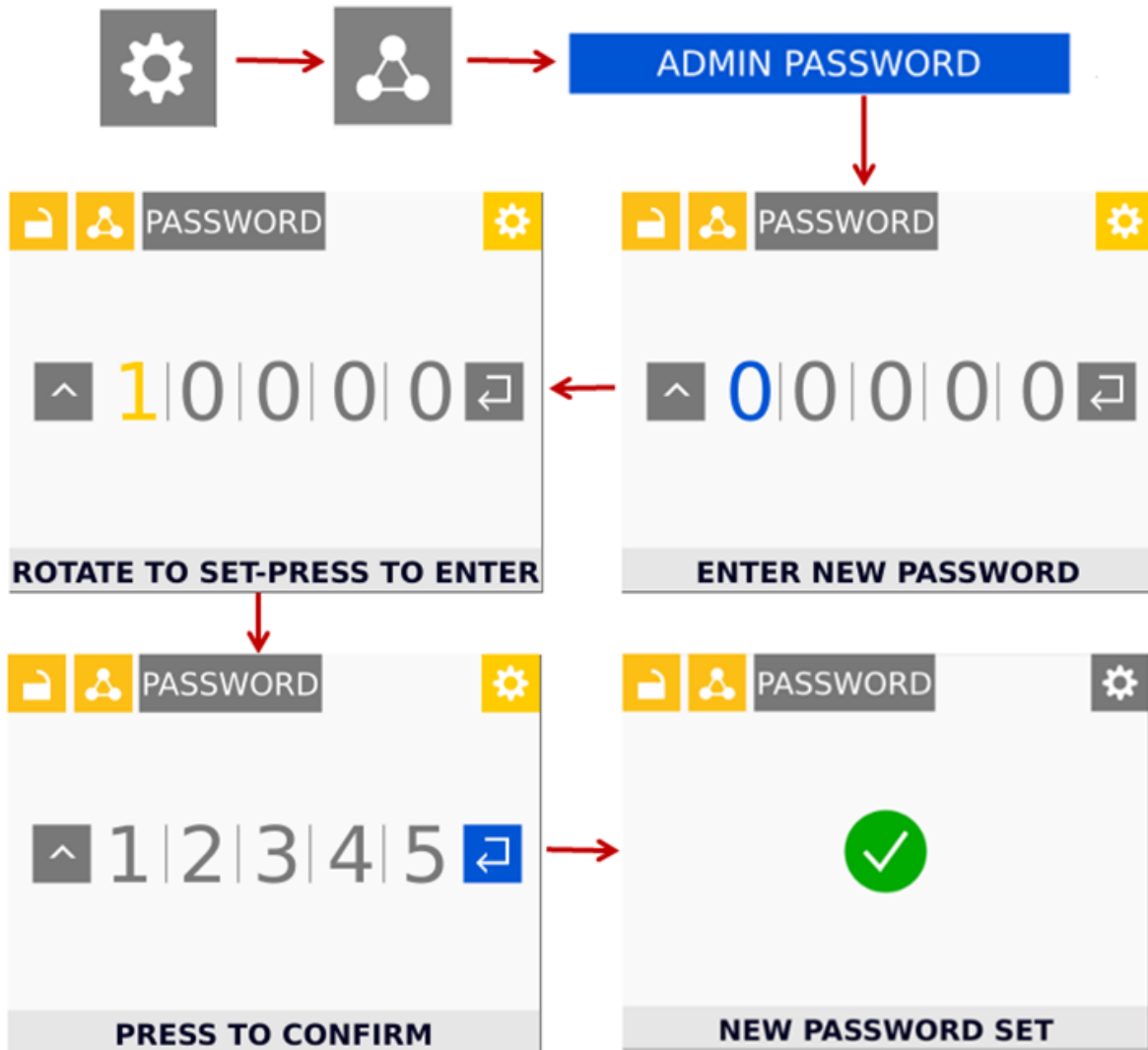
**PRODUCTION ON BOOT** - Controller enters production mode immediately after power-up.

## Admin Password Screen

Set up the admin password as instructed below.

The password is typed and confirmed in the password screen via the rotary push button. The Password fields only accept a numeric password from 0 to 9 in each column, the password must have 5 characters. Follow the steps shown below to entry a new password.

**Figure 27.**  
New Password Screens



## Swap Between Admin and Production Mode

**To change from admin mode to production mode:** Select the padlock icon at the upper left corner of the screen (which is unlocked) using the rotary push button. Push the center of the rotary push button. The padlock icon will become locked. This indicates that the mode has switched to production mode.

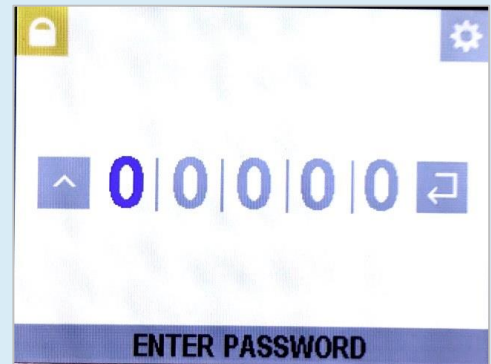
**To change from production mode to admin mode:** Select the padlock icon at the upper left corner of the screen (which is locked) using the rotary push button. Push the center of the push button. The “Enter Password Screen” will appear.

Enter the admin password which was set up in Figure 27, or the default password, **00000**. Confirm the password to enter the admin mode.

**Figure 28.**  
Padlock Icon for Admin and Production Mode



**Figure 29.**  
Enter Password Screen










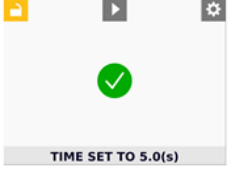
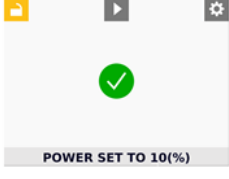



**Figure 30.**  
Confirm Password Screen



## Irradiation Setup

To start a new irradiation, it is necessary to confirm TIME and POWER values. These values can be changed in admin mode only. To modify the values, follow the steps shown below.

**Table 3.**  
Irradiation Setup

Time Setting	Power Setting	Operation
		<p>To choose between the TIME or POWER settings, turn the dial to the desired setting, it will turn blue, then press the dial, the time and power level screen will be accessed.</p>
		<p>TIME: The irradiation time is shown in the first column on the heading “Time (s)”. The input range is from 0.1 to 999.9 seconds with a resolution of 0.1(s), set the number one by one until get the desired time.</p> <p>POWER: The cure power intensity is displayed as a percentage in the second column, above the heading “Power (%)”. Power may be set from 10 to 100%, the adjustment can be made in increments of 1%.</p>
		<p>When the selected value has been the desired, place the rotary push button on the enter symbol , then press the rotary push button to set the new TIME or POWER values and return to the previous menu.</p>
		<p>A success screen will appear when the established data are valid.</p>
		<p>The setup is complete and the unit is ready to start a new irradiation by pressing the rotary push button. </p>

## Curing Time Screen

By pressing the time display/button you can access the timer setting. You must turn rotary push button to select the desired time and press it to accept the set value (Figure 31). The entry range is from 0.1 to 999.9 seconds with a resolution of 0.1(s).

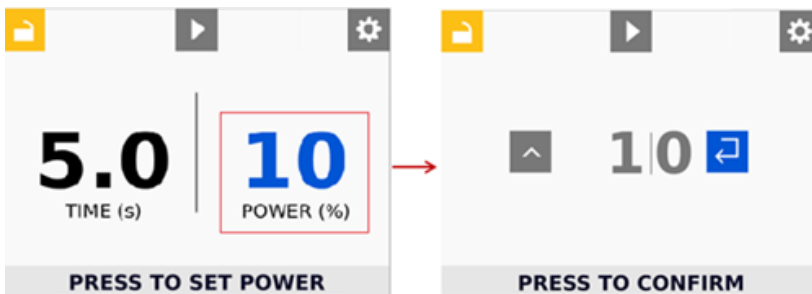
**Figure 31.**  
Curing Time Display



## Power Level Screen

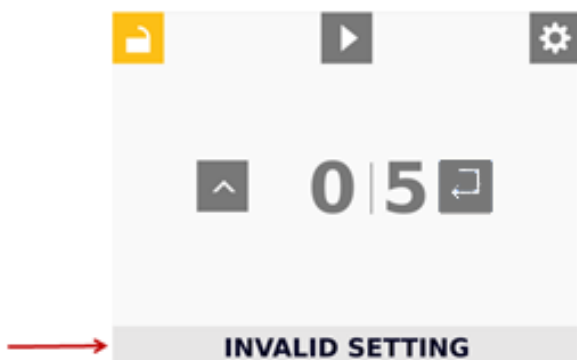
By pressing the power display/button you can access the power setting. You must turn rotary pushbutton to select the desired power and press it to accept the set value (Figure 32). The power level range is 10 to 100% in increments of 1%.

**Figure 32.**  
Power Level Screen



**Note:** the minimum power value to configure LED intensity must be 10% to avoid linearity in irradiation area intensity. If the set value is less than 10, it will be taken as an invalid setting and it will be necessary to enter a new value.

**Figure 33.**  
Invalid Setting Screen



## Irradiation in Production or Admin Mode

To run the exposure cure cycle in Production or Admin mode, a timer and power setting is required.

### Timer

The timer can be setup in Admin mode only. The range of the timer is 0 to 999.9 seconds.

If the timer is set to 0, the UV LED will be controlled by the push button and/or the Foot Pedal (if connected to TRIGGER/TRIGGER COM input). When the push button or the Foot Pedal is pushed down, the UV will turn on; when both the push button or Foot Pedal are released, the UV will turn off.

If the timer is set to non-zero value, the Rotary Pushbutton or the Foot Pedal will start the UV LED, and the timer will count down.

When the timer counts down to zero, the UV LED will turn off. The timer is reset to the pre-set value, and the system is ready to run another exposure cycle.

A timed cycle may be interrupted before the timer counts down to zero. You may re-assert the trigger by Rotary Pushbutton or Foot Pedal during the cycle and it will turn off the UV LED immediately and reset the timer to the pre-set value, and the system is ready to run another exposure cycle.

### Power

The UV power level can be set in the Admin Mode. The range is from 10% to 100% of the full power.

Figure 34 shows the operation interface in Timer Mode. To select RUN, turn the rotary pushbutton to move the highlight over the RUN icon, then push the center of the Rotary Pushbutton. This will run and stop the LEDs' irradiation.

If the Foot Pedal is connected, pressing the Foot Pedal can highlight the RUN icon immediately, no matter which icon was highlighted before.

If the timer is set to 0, pressing the Foot Pedal will turn on the UV LED; releasing the Foot Pedal will turn off the UV LED.

**Figure 34.**  
Timer Mode Interface





## Irradiation in PLC mode

When in PLC mode, an external PLC can control the unit. The PLC provides input signals to the AX-550 LED Flood System to control the on/off signals and intensity of the LEDs. The PLC can also monitor the status of the system by reading output signals provided by the unit.

**Figure 35.**  
PLC Mode Screen States



### PLC Screen Detailed Description:

1. **LED ON/OFF Input:** The status of UV LED control input (PIN 6 in ). The screen shows **TRUE (1a)** when the input is connected to common to turn on the UV LED; and shows **FALSE (1b)** when the input is open and the UV LED should be off. The minimum signal pulse width High or Low is 500ms.
2. **LED Inhibit:** The input status of **LED INHIBIT (PIN 15 in )**. Enables or prevents the UV irradiation, to allow irradiation, the screen must display a **FALSE state (2.a, ab)**. When irradiation is disabled a **TRUE state** will be seen. LED inhibit is typically wired to the door of a **Light Shield** unit. When LED Inhibit line is not connected to common, an error warning of **LED INHIBIT OPEN** will be seen.
3. **LED Activated:** Displays the UV LEDs irradiation status as ON (**3.a TRUE**) or OFF (**3.b FALSE**).
4. **LED Intensity (%):** Indicates the light intensity percentage value (**4a, 4b**) for the next time when the UV LEDs will operate, The value can be set by either **ANALOG INTENSITY** input (PIN3 in ) in PLC mode or the control panel in Admin mode.
5. **LED Intensity Control:** The status of **INTENSITY** source (PIN7 in ). Displays whether the LED light Intensity is controlled via PLC's **ANALOG INTENSITY** pin. **PLC (5.a)** or whether the last power value set on the control panel **PANEL**.

**If the Intensity is set by the ANALOG INTENSITY input, the intensity value will be locked when the LED is activated. The LED Intensity setting can change according the ANALOG INTENSITY input but will take affect only at the time that the LED become Activated.**

6. **Master Interlock:** The input status of the **MASTER INTERLOCK (PIN5 in )** is shown as **FALSE (6a, 6b)** if the pin connected to common and shown as **TRUE** if the pin is open. The **TRUE** input will disable the UV operation, and an error warning **MASTER INTERLOCK OPEN** will be shown on the bottom of the screen. For normal operation, the status should be **FALSE**, ie, the pin should be connected to common.

## To run a curing cycle in PLC mode:

1. Assert the PLC ENABLE input (connect the input to COM), PLC screen should appear.
2. Set the intensity level source by toggling the LED INTENSITY INT/EXT line. INTERNAL mode uses the value set in the controller. EXTERNAL source requires a voltage input based on a 1 volt DC = 10% power up to 10 volts DC for 100%.
3. Assert both MASTER INTERLOCK and LED INHIBIT (connected both to COM), then assert the LED ON/OFF line, the system starts the irradiation, irradiation will end when de-asserting the LED ON/OFF.

**Figure 36.**

PLC Screen, UV LED Inactivated (Off)

RediCure	
LED ON/OFF Input	FALSE
LED Inhibit	FALSE
LED Activated	FALSE
LED Intensity(%)	50%
LED Intensity Control	PLC
Master Interlock	FALSE

UNIT DIAGNOSTIC/PLC

**Figure 37.**

PLC Screen, UV LED Activated (On)

RediCure	
LED ON/OFF Input	TRUE
LED Inhibit	FALSE
LED Activated	TRUE
LED Intensity(%)	50%
LED Intensity Control	PLC
Master Interlock	FALSE

UNIT DIAGNOSTIC/PLC

## Maintenance

### Product Cleaning

Product cleaning is limited to wiping the product with a damp cloth. Do not soak. Isopropyl Alcohol and mild detergent may be used for cleaning the product.

### Emitter Replacement

To replace the emitter, follow these steps:

1. Place the unit on a flat surface and remove the 4 M3 Screws located on the sides using a 2.0-mm Philips Screwdriver. (Figure 38)
2. Remove the Emitter section carefully and replace it with the desired Emitter. (Figure 39)
3. Reinstall the 4 M3 Screws Removed in Step 1 (Figure 40). The unit is now ready to be used.

**Figure 38.**  
Remove M3 Screws



**Figure 39.**  
Remove Emitter Section



**Figure 40.**  
Replace Emitter and Reinstall Screws



## Replace Fuse

To replace the fuse, follow these steps:

1. Open the Fuse Cover using flat screw driver. (Figure 41)
2. Lift the Fuse Holder using the flat screw driver. (Figure 42)

**Figure 41.**  
Open Fuse Cover



**Figure 42.**  
Lift Fuse Holder



3. Take out the Fuse Holder. (Figure 43)
4. Replace the fuse and put everything back. (Figure 44)

**Figure 43.**  
Remove Fuse Holder



**Figure 44.**  
Replace Fuse



# Troubleshooting

**WARNING!** Only qualified maintenance personnel should attempt the following procedures:

**Table 4.**  
Troubleshooting Chart for BlueWave AX-550 Flood Curing System

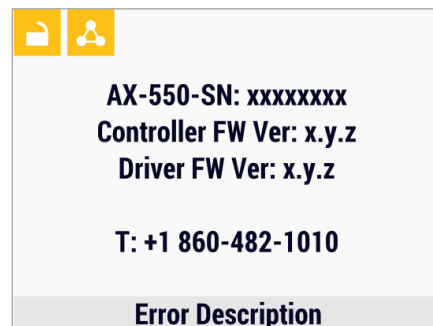
Problem	Possible Cause	Corrective Action
BlueWave AX-550 system does not power up	Power cord not plugged in or damaged.	Check power connection and condition at power source and AC Inlet of the unit.
	No electrical power at Receptacle.	Test Receptacle for power.
BlueWave AX-550 system powers up but the emitter does not emit light	MASTER INTERLOCK and/or LED INHIBIT is open.	Verify both of MASTER INTERLOCK and LED INHIBIT are connected to common directly or through the safety sensor. Verify PLC command structure for PLC mode.
	Emitter is not connected to the Controller.	Verify that the Emitter is connected to the Controller.
BlueWave AX-550 system is operating normally and the emitter suddenly stops emitting light	Over-temperature shutdown was triggered.	Verify error information.
	MASTER INTERLOCK or LED INHIBIT is open.	Verify interlock jumpers are in place. Verify PLC command structure for PLC mode.
LED emitter provides only low-intensity light	LED intensity set too low.	Increase LED intensity setting on Admin Settings or I/O input for PLC Mode.
	Contaminated/dirty lens optics.	Clean the surface of the Lens.
Footswitch does not function correctly	Footswitch not connected or connected to wrong I/O connector pins.	Verify connections to Pins 13 & 14 of the I/O connector.
	Footswitch defective.	Activate unit using the front panel rotary pushbutton. Replace the footswitch if the unit operates from the rotary pushbutton.

## Error Screen

If the unit is powered up, and some error happens, the error screen will appear.

The error screen will display the system serial number, controller and driver firmware versions, a technical support phone number for more information, and the current error description.

**Figure 45.**  
Error Screen



**Table 4.**  
Error Descriptions & Possible Causes

Original Error Description	Possible Cause
Input 24V Low Voltage	Failure on 24V PSU or PSU cabling
Controller Temperature High	Controller temperature found higher than 80 degrees
Controller Fan Not Running	Fan wire maybe disconnected or fan motor malfunctions
Operation Mode Changed	Operation mode change requires a unit reset.
I2C Comm Error	Possible EEPROM chip error
PLC Mode Changed	Mode changed due to switching when power is turned on
PLC LED Inhibit (Chamber Door) open	Chamber door not closed (LED Inhibit PLC line not asserted)
PLC Power Short	Voltage on PLC Power Signal is less than 20VDC, or cable not firmly connected
Driver 0/1/2/3 24V Low Voltage	24V power supply of Driver 0/1/2/3 bad
Driver 0/1/2/3 Temperature 90	Fan not working properly, or air intake blocked
Driver 0/1/2/3 Temperature 80	Fan not working properly, or air intake blocked
Driver 0/1/2/3 Fault Out	LED error found and notified by Driver 0/1/2/3
Driver 0/1/2/3 Comm Bad	Bad communication due to error signal
Driver 0/1/2/3 Channel 0/1 LED Temperature 90	Fan not working properly, or air intake blocked
Driver 0/1/2/3 Channel 0/1 LED Temperature 80	Fan not working properly, or air intake blocked
Driver 0/1/2/3 Channel 0/1 LED Temperature 70	Fan not working properly, or air intake blocked
Driver 0/1/2/3 Channel 0/1 LED Temperature 0	ADC chip malfunction
Driver 0/1/2/3 Channel 0/1 LED Temperature Low	LED working temperature of Ch0/1 of Driver 0/1/2/3 found lower than low limit
Driver 0/1/2/3 Channel 0/1 LED Temperature High	LED working temperature of Ch0/1 of Driver 0/1/2/3 found higher than high limit
Driver 0/1/2/3 Channel 0/1 LED Voltage Low	LED working voltage of Ch0/1 of Driver 0/1/2/3 found higher than high limit
Driver 0/1/2/3 Channel 0/1 LED Voltage High	LED working voltage of Ch0/1 of Driver 0/1/2/3 found lower than low limit
Driver 0/1/2/3 Channel 0/1 LED Current Low	LED working current of Ch0/1 of Driver 0/1/2/3 found higher than high limit
Driver 0/1/2/3 Channel 0/1 LED Current High	LED working current of Ch0/1 of Driver 0/1/2/3 found lower than low limit
Driver 0/1/2/3 Channel 0/1 LED Out	LED of Ch0/1 of Driver 0/1/2/3 found bad
Driver 0/1/2/3 Channel 0/1 LED NA	LED of Ch0/1 of Driver 0/1/2/3 not found
Driver 0/1/2/3 UART Bad	UART of driver 0/1/2/3 found bad
Driver 0/1/2/3 Incompatible	Driver 0/1/2/3 firmware version not compatible with controller
Nvram Array None	No U-shaped board found or no NVRAM chip found
Nvram Array Bad	The data structure maybe bad
Nvram Driver 0/1/2/3 Bad	NVRAM of driver 0/1/2/3 found bad
Nvram Pc Uart Tx Bad	Possible communication error from computer
Nvram Data NA	No data found in the NVRAM
Nvram Operation Both Bad	No programming or chip error

# Workplace Safety Testing

The power entry filter design on the BlueWave AX-550 employs metal oxide varistors (MOVs) to protect the unit from power input surges. There is a potential for the unit to fail insulation resistance with standard test systems designed to meet the DGUV 3 test needs. The MOVs will conduct a small amount of current, which will be detected by the standard testers, and report a failure. This is not considered an unsafe condition, and the test must be altered to account for this.

We recommend using a test voltage of 250V DC in accordance with VDE 0701-0702 for measuring the insulation resistance. The integrated protective filter requires mains voltage to function properly. The measurement of the protective conductor and touch current is mandatory in this case.

## Spare Parts & Accessories

### Accessories

Item	Part Number
Personal Protection Equipment	
Protective Goggles — Green	35286
Protective Goggles — Gray (standard model included with unit)	35285
Face Shield	35186
Radiometer	
ACCU-CAL™ 50-LED Radiometer	40505
Stands	
Mounting Stand	43410
Three-Sided Acrylic Shield	41395

### Components & Spare Parts

Item	Part Number
BlueWave AX-550 System Controller	43331
BlueWave AX-550 Emitter, VisiCure (405 nm)	43250
BlueWave AX-550 Emitter, PrimeCure (385 nm)	43249
BlueWave AX-550 Emitter, RediCure (365 nm)	43248
Power Cord, North America	35255
Power Cord, Right Angle, North America	43435
Power Cord, Type G	40542
Power Cord, Right Angle, Asia	43450
Power Cord, Right Angle, EU	43449
Foot Pedal	43106
Quartz Glass Replacement Kit	43413
Firmware Upgrade Card for V2.0 Emitters	61883

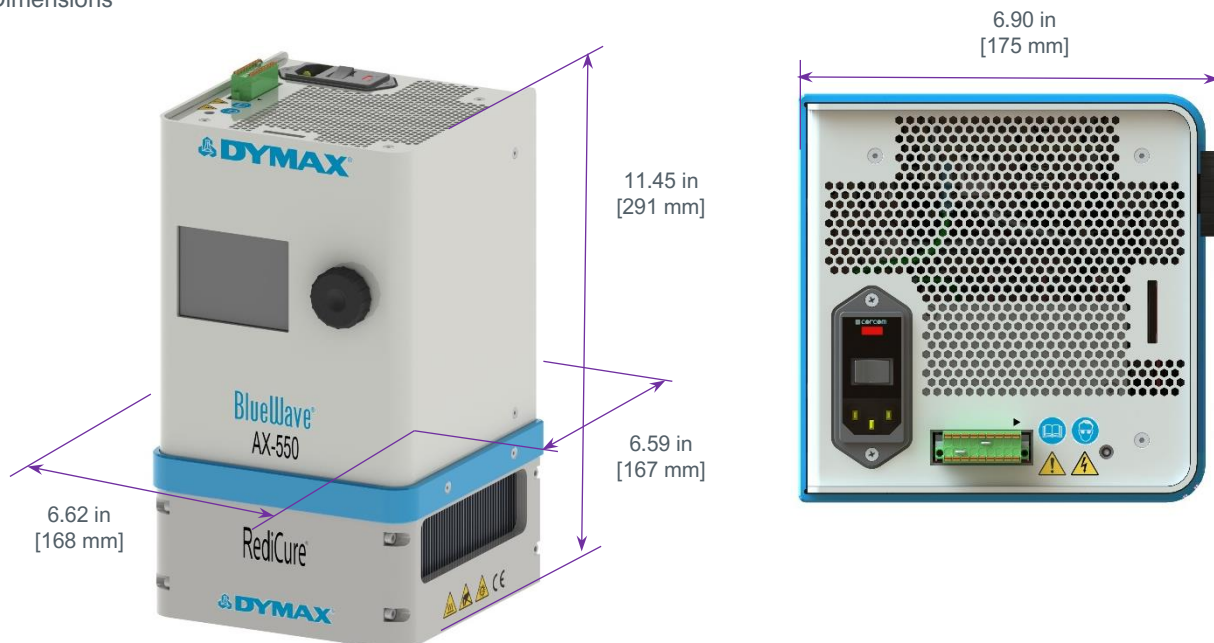
# Specifications



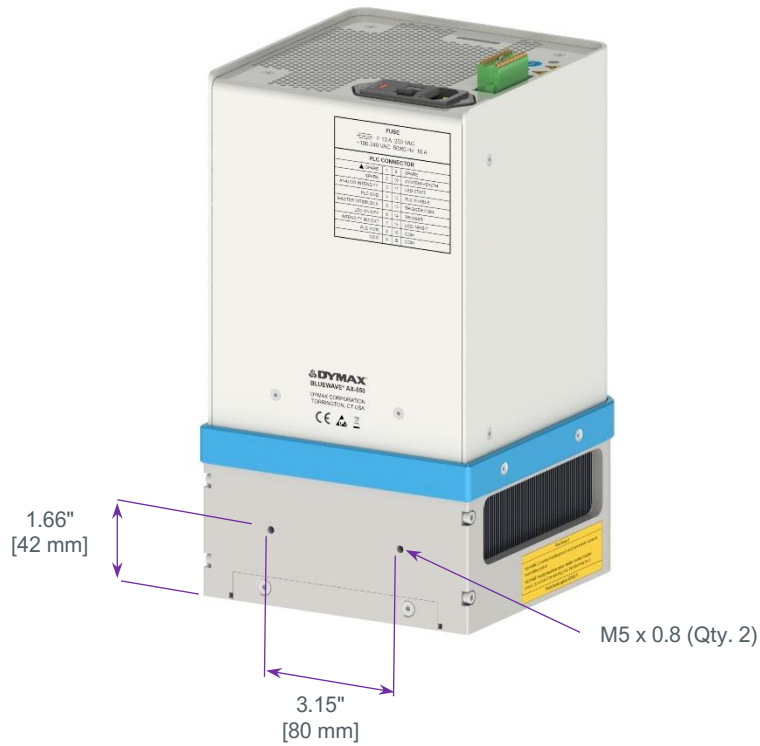
Property	Specification		
Emitter	RediCure	PrimeCure	VisiCure
Output Frequency	365 nm	385 nm	405 nm
Intensity Output at 25-mm Working Distance	425 mW/cm <sup>2</sup> *	800 mW/cm <sup>2</sup>	650 mW/cm <sup>2</sup>
Curing Area	5" x 5" [125 mm x 125 mm]		
Power Requirements	100-240 V $\approx$ 10 Amps, 50-60 Hz		
Cooling	Air cooled		
Dimensions (W x D x H)	11.45" x 6.88" x 6.61" [29.1 cm x 17.5 cm x 16.8 cm]		
Weight	14.1 lbs. [6.4 kg]		
Unit Warranty	1 year from purchase date		
Operating Environment	10°C to 40°C (50°F to 104°F) 0 - 80% relative humidity, non-condensing (recommended: 30% RH) 2,000-meter max. altitude		
Shipping and Storage Conditions	Temperature: -20°C to +50°C Humidity: 10 - 80% RH, non-condensing Ship via standard ground, ocean, or air freight		
Certifications	RoHS, CE Marked		

\* RediCure intensity is for reference only. See PB065 for the latest data.

**Figure 46.**  
Dimensions



**Figure 47.**  
Mounting Hole Locations and Size



**Table 5.**  
Operation Timing

Input Event	Out Event	Test Condition	Maximum Time Delay
LED ON/OFF Change to Low	UV LED ON	PLC Mode	20 ms
	LED STATE Output Change to LOW		25 ms
LED ON/OFF Change to High	UV LED OFF		30 ms
	LED STATE Output Change to High		40 ms
TRIGGER Close	UV LED ON	Manual Mode	150 ms
	LED STATE Output Change to LOW		180 ms
TRIGGER OPEN	UV LED OFF		25 ms
	LED STATE Output Change to High		50 ms
TRIGGER Asserted (Change form OPEN to CLOSE)	UV LED ON	Timer Mode	140 ms
	LED STATE Output Change to Low	UV LED is OFF	150 ms
	UV LED OFF	Timer Mode	140 ms
	LED STATE Output Change to High	Before Timer expired UV LED is ON	160 ms



## Validation

Tests should be conducted prior to production to determine the time and light intensity required to fully cure your resin. The following approaches may be used to validate the curing process.

### Set Exposure Time, Determine Intensity

Users can specify a cure time and, through empirical testing, determine the intensity required to achieve a full cure. As with any manufacturing process, it is advisable to incorporate a safety factor.

### Set Intensity, Determine Exposure Time

Users can specify light intensity and, through empirical testing, determine the exposure time required to achieve a full cure. As with any manufacturing process, it is advisable to incorporate a safety factor.

**NOTE:** *Dymax recommends intensities low at first to preserve LED life.*

Contact the Dymax Application Engineering Team for additional process support.

## Control

Process validation confirms a minimum acceptable intensity. Users can then choose to operate at full intensity (using the excess intensity as an additional safety factor) or adjust the output to a specific intensity level. To ensure consistent and repeatable process results, intensity levels should be monitored with a radiometer. This enables users to identify light intensity changes and take corrective action (either adjusting the light intensity or performing maintenance).

## Warranty

From date of purchase, Dymax Corporation offers a one-year warranty against defects in material and workmanship on all system components with proof of purchase and purchase date. Unauthorized repair, modification, or improper use of equipment may void your warranty benefits. The use of aftermarket replacement parts not supplied or approved by Dymax Corporation, will void any effective warranties and may result in damage to the equipment.

**IMPORTANT NOTE:** *DYMAX CORPORATION RESERVES THE RIGHT TO INVALIDATE ANY WARRANTIES, EXPRESSED OR IMPLIED, DUE TO ANY REPAIRS PERFORMED OR ATTEMPTED ON DYMAX EQUIPMENT WITHOUT WRITTEN AUTHORIZATION FROM DYMAX. THOSE CORRECTIVE ACTIONS LISTED ABOVE ARE LIMITED TO THIS AUTHORIZATION.*

**Figure 48.**  
Declaration of Conformity



Declaration of Conformity

Responsible Party:  
DYMAX Corporation  
318 Industrial Lane  
Torrington, CT 06790, USA

European Address:  
DYMAX Europe GmbH  
Kasteler Str.45  
Geb.G359  
Wiesbaden Germany 65203

UK Address:  
Dymax  
1b Hunts Grove Drive, Hardwick,  
Gloucester, Gloucestershire, GL2 4BH  
United Kingdom

Product description: Bluewave® AX-550 LED Flood Curing System  
Model name(s): AX-550

*This product complies with the following Directives, legal acts and standards:*

**European Union Compliance (CE)**

**Electromagnetic Compatibility Directive (2014/30/EU):**  
EN 55011:2016/A11:2020  
EN 61000-3-2:2014 Class A  
EN 61000-3-3:2013  
EN 61326-1:2013

**Low Voltage Directive (2014/35/EU):**  
EN 61010-1:2010 AMD1:2019

**RoHS Directive EU (2015/863)**

**Other Regulatory Compliance**

**USA: UL 61010-1:2012**  
With R:2015-07 + R:2016-04 + R:2018-11-16 + R:2018-11-21 +  
R:2019-07

**Canada: CAN/CSA-C22.2 No. 61010-1:2012**  
With U1:2015-07 + U2:2016-04 + A1:2018-11

**Photo-biological Safety**  
EN 62471:2008  
Risk Group 3

**Declaration:**

*I declare that the above information in relation to the supply and manufacture of this product is in conformity with the above standards and directives.*



T. Trudeau 9/28/21  
Name Date

Authorized Signatory:  
Toby Trudeau  
Engineering Manager  
DYMAX Corporation  
Torrington, CT., USA

Representative in Europe:  
Dominik Stephan  
Director, Equipment  
DYMAX EUROPE GmbH  
Wiesbaden, Germany

Representative in UK:  
Kevin Westcott  
Account Manager  
DYMAX  
Gloucester, Gloucestershire UK

[www.dymax.com](http://www.dymax.com)

**Americas**  
USA | +1.860.482.1010 | [info@dymax.com](mailto:info@dymax.com)

**Europe**  
Germany | +49 611 962.7900 | [info\\_de@dymax.com](mailto:info_de@dymax.com)  
Ireland | +353 21 237.3016 | [info\\_ie@dymax.com](mailto:info_ie@dymax.com)

**Asia**  
Singapore | +65.67522887 | [info\\_ap@dymax.com](mailto:info_ap@dymax.com)  
Shanghai | +86.21.37285759 | [dymaxasia@dymax.com](mailto:dymaxasia@dymax.com)  
Shenzhen | +86.755.83485759 | [dymaxasia@dymax.com](mailto:dymaxasia@dymax.com)  
Hong Kong | +852.2460.7038 | [dymaxasia@dymax.com](mailto:dymaxasia@dymax.com)  
Korea | +82.31.608.3434 | [info\\_kr@dymax.com](mailto:info_kr@dymax.com)

# Index

**Accessories, 30**

## **Connections**

- Connecting Foot Pedal, 12
- Connecting the Inhibit/Interlock PLC controls, 11
- Connecting the Power Cord, 11
- I/O Interface Summary, 10
- PLC UV Control, 12
- Status output, 13

**Contact Information, 4**

**Help, 4**

**Installation, 7**

## **Maintenance**

- Emitter Replacement, 26
- Product Cleaning, 26
- Replacing the Fuse, 27

## **Operation**

- Irradiation in PLC mode, 25
- Irradiation in Production or Admin Mode, 24
- Irradiation Setup, 22
- System Initializing, 16

**Optional Equipment, 30**

**Parts Included, 6**

**Product Overview, 5**

**Safety, 4**

**Spare Parts, 30**

**Specifications, 31**

**Support, 4**

## **System Assembly**

- Connections, 9
- System Cooling, 7
- Wiring and Connections, 8

## **System Screens**

- Curing Time Screen, 23**
- Power Level Screen, 23**
- Settings Screen, 17**

## **System Settings, 17**

- Admin Only Settings, 19**
- General Settings, 17
- Swapping between Admin and Production Mode, 21

**Troubleshooting, 28**

**Unpacking, 6**

## **Validation**

- Control, 33
- Setting Exposure Time, Determining Intensity, 33
- Setting Intensity, Determining Exposure Time, 33

**Warranty, 33**

**Workplace Safety Testing: DGUV 3, 30**



[www.dymax.com](http://www.dymax.com)

**Americas**

USA | +1.860.482.1010 | [info@dymax.com](mailto:info@dymax.com)

**Europe**

Germany | +49 611.962.7900 | [info\\_de@dymax.com](mailto:info_de@dymax.com)

Ireland | +353 21.237.3016 | [info\\_ie@dymax.com](mailto:info_ie@dymax.com)

**Asia**

Singapore | +65.67522887 | [info\\_ap@dymax.com](mailto:info_ap@dymax.com)

Shanghai | +86.21.37285759 | [dymaxasia@dymax.com](mailto:dymaxasia@dymax.com)

Shenzhen | +86.755.83485759 | [dymaxasia@dymax.com](mailto:dymaxasia@dymax.com)

Hong Kong | +852.2460.7038 | [dymaxasia@dymax.com](mailto:dymaxasia@dymax.com)

Korea | +82.31.608.3434 | [info\\_kr@dymax.com](mailto:info_kr@dymax.com)

© 2019-2021 Dymax Corporation. All rights reserved. All trademarks in this guide, except where noted, are the property of, or used under license by Dymax Corporation, U.S.A.

Please note that most curing system applications are unique. Dymax does not warrant the fitness of the product for the intended application. Any warranty applicable to the product, its application and use is strictly limited to that contained in Dymax's standard Conditions of Sale. Dymax recommends that any intended application be evaluated and tested by the user to ensure that desired performance criteria are satisfied. Dymax is willing to assist users in their performance testing and evaluation by offering equipment trial rental and leasing programs to assist in such testing and evaluations. Data sheets are available for valve controllers or pressure pots upon request.

MAN095 11/16/2021