

Model 455 Disposable Fluid Path Valve

User Guide

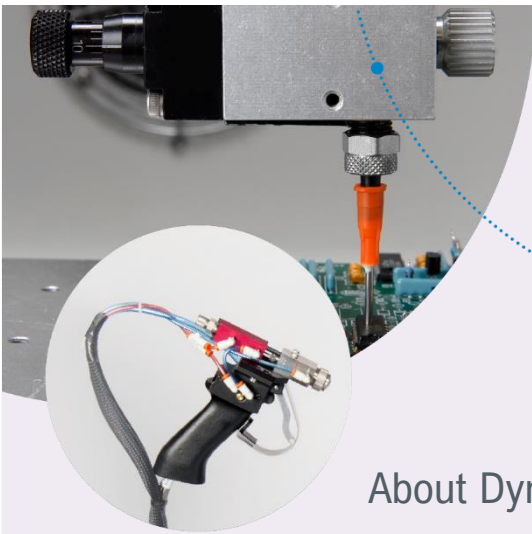



About Dymax

Light-curable adhesives. Systems for light curing, fluid dispensing, and fluid packaging.

Dymax manufactures industrial adhesives, light-curable adhesives, epoxy resins, cyanoacrylates, and activator-cured adhesives. We also manufacture a complete line of manual fluid dispensing systems, automatic dispensing systems, and light-curing systems. Light-curing systems include LED light sources, spot, flood, and conveyor systems designed for compatibility and high performance with Dymax adhesives. Dymax adhesives and light-curing systems optimize the speed of automated assembly, allow for 100% in-line inspection, and increase throughput. System designs enable stand-alone configuration or integration into your existing assembly line.

Please note that most dispensing and curing system applications are unique. Dymax does not warrant the fitness of the product for the intended application. Any warranty applicable to the product, its application, and use is strictly limited to that contained in the Dymax standard Conditions of Sale. Dymax recommends that any intended application be evaluated and tested by the user to ensure that desired performance criteria are satisfied. Dymax is willing to assist users in their performance testing and evaluation. Data sheets are available for valve controllers or pressure pots upon request.

Contents

Introduction	4
Where to Get Help.....	4
Safety	4
General Safety Considerations	5
Specific Safety Considerations.....	5
Product Overview	5
Description of the Model 455 Dispensing Valve.....	5
Special Features and Benefits of the Model 455.....	7
Over-Pinch Adjustment.....	7
Disposable Fluid Path	7
Assembly and Setup	8
Unpacking and Inspecting Your Shipment.....	8
Tubing Installation	9
Mounting.....	10
System Interconnect.....	11
Valve Setting Adjustments	11
Operating the Dispensing Valve	14
Start Up.....	14
Dispense.....	14
Maintenance	17
Seal Replacement	17
Troubleshooting	18
Spare Parts and Accessories	19
Options/Accessories	19
Replacement Tubing Assemblies/ Conversion Kits	20
Specifications	21
Warranty	23
Index	23

Introduction

This guide describes how to use the Dymax Model 455 pinch valve. Sections in this guide describe how to assemble, use, and maintain the dispensing valve safely and efficiently.

Intended Audience

Dymax prepared this user guide for experienced process engineers, maintenance technicians, and manufacturing personnel. If you are new to pneumatically operated fluid dispensing equipment and do not understand the instructions, contact the Dymax Application Engineering to answer your questions before using the equipment.

Where to Get Help

Customer Support and Applications Engineering teams are available by phone and email in Germany, Monday through Friday, from 8:00 a.m. to 5:00 p.m. Central European Time. You can also email Dymax Europe GmbH at info_de@dymax.com. Please see the back cover for worldwide contact information. For more information about this product, visit dymax.com.

Additional resources are available to ensure a trouble-free experience with our products:

- Detailed product information on www.dymax.com
- Dymax adhesive Product Data Sheets (PDS) on our website
- Safety Data Sheets (SDS) provided with shipments of Dymax adhesives

Safety



WARNING! *If you use this fluid dispensing valve without first reading and understanding the information in this guide, personal injury can result from the uncontrolled release of high-pressure gas, injection, or exposure to chemicals. To reduce the risk of injury, read and understand this guide before assembling and using Dymax fluid dispensing valves.*

General Safety Considerations

All users of Dymax fluid dispensing equipment should read and understand this user guide before assembling and using the equipment.

To learn about the safe handling and use of dispensing fluids, obtain and read the SDS for each fluid before using the fluid. Dymax includes an SDS with each adhesive sold. SDS for Dymax products can also be requested on the Dymax website.

Specific Safety Considerations

Using Safe Operating Pressures

Pressurizing the components in the dispensing system beyond the maximum recommended pressure can result in the rupturing of components and serious personal injury. To minimize the risk of rupturing components and injury, do not exceed the maximum operating pressure of the components in your fluid dispensing system (see system specifications on page 21).

Preventing Injection Injury

Discharging fluids or compressed air with a dispensing tip against your skin can cause very serious injection injury. To minimize the risk of injection injury, do not place the dispensing tip in contact with your skin.

Product Overview

Description of the Model 455 Dispensing Valve

The Model 455 valve is a pneumatically operated, normally closed pinch valve. This valve features micrometer control over flow (the amount the tube opens) and precise control over tube closure, ensuring the accuracy and repeatability of operation and greatly extending tube life.

Teflon® tubing is recommended for use with the Model 455, but the valve is supplied with all the components required for use with silicone, urethane, or vinyl tubing.

The 455 valve may be used as a dispense valve or as an in-line, two-way (on-off) valve with adjustable flow. The Dymax DVC-345 valve controller or a user-supplied device can be used to operate the valve.

Figure 1.
Model 455 Internal Component Diagram

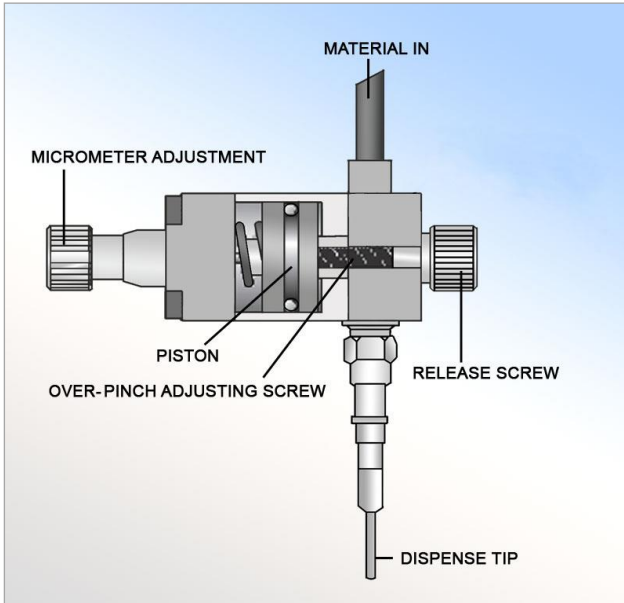

Spray Valve Configuration

The Model 455 valve can be outfitted with a micro-spray nozzle and a spray regulator assembly for spray applications. The spray nozzle is an all-stainless, external air-mix type that utilizes a standard Luer-Lock design allowing for different gauge tips to be exchanged to adjust flow rate needs across applications. The combination of tip variation and integrated pneumatic controls allows control over the amount of air relative to the amount of fluid. The controls also feature a built-in delay system that atomizes the tiny droplet that would normally remain on the nozzle when the valve is shut off. This enhances repeatability and guarantees drip-free operation.

Special Features and Benefits of the Model 455

Feature	Benefit
Over-Pinch Adjustment	Prevents tubing damage, allowing users to secure millions of cycles from tubing before replacement is required
Disposable fluid path	Eliminates material contamination during dispense
	Prevents air entrapment during the dispensing process
	Allows for easy product changeover with minimal cleanup
	The fluid never comes in contact with the valve's internal components, reducing valve maintenance and extending the life of the valve
Optional spray nozzle available	Allows the valve to be used for a variety of micro-spray applications

Over-Pinch Adjustment

Dymax's disposable fluid path valves contain a unique over-pinch adjustment. This feature prevents damage to the fluid path, extending the life of the tubing and reducing how often it needs to be replaced.

Disposable Fluid Path

The Model 455 valve features a disposable fluid path constructed of tubing. Fluids are carried from the material reservoir to the dispense tip in a completely sealed path, ensuring no contact with the valve's internal components. This reduces wear to the valve's internal components, reducing valve maintenance and extending the valve's life. It also ensures that fluids remain contaminate free throughout the dispensing process.

The Model 455 is compatible with a variety of different tubing sizes and materials, allowing complete compatibility with the fluids being dispensed. The disposable fluid path is easy to replace and change out, making material changeover simple with little or no cleanup.

Assembly and Setup

Unpacking and Inspecting Your Shipment

When your Model 455 dispensing valve arrives, inspect the box for damage and notify the shipper of box damage immediately.

Open the box and check for equipment damage. If parts are damaged, notify the shipper and submit a claim for the damaged parts. Contact Dymax so that new parts can be shipped to you immediately.

Check that the parts included in your order match those listed below. If parts are missing, contact your local Dymax representative or Dymax Customer Support to resolve the problem.

Figure 2. Model 455 Pinch Valve



Figure 3. Model 455 Spray



Parts Included in the Model 455 Dispensing Valve

- Model 455 pinch valve
- Tubing – Size and type dependent on individual selection
- Assorted dispense tip kit
- Model 455 user guide
- Optional: Spray nozzle attachment (only included with spray configurations)

Tubing Installation

Model 455 Dispensing Valve

1. Remove the Tube Support Assembly from the Valve Body by loosening and removing the Release Screw.
2. Remove the existing tube from the Tube Support Assembly by unscrewing the Tube Fastener Screw and removing the tube from the Tube Adapter.
3. Install a new tube by running the tube through the Tube Support Assembly and installing the tubing over the Tube Adapter.
4. Tighten the Tube Fastener Screw and insert the Tube Support Assembly into the Valve Body.

Figure 4.
Tubing Installation Procedure – Standard Model 455 Valve

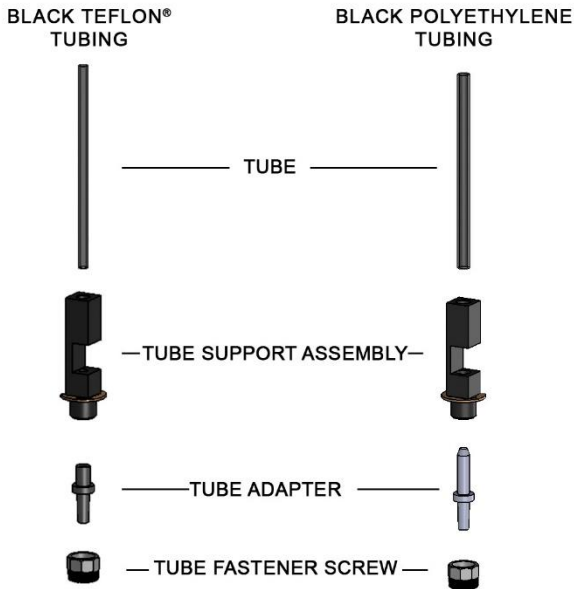

Model 455 Spray Valve

1. Remove the Tube Support Assembly from the Valve Body by loosening and removing the Release Screw.
2. Remove the Atomizing Head by loosening the Hex Nut.
3. Unscrew and remove the Tube Fastener Collar from the Tube Support Assembly.
4. Remove the Needle Tip.
5. Remove any Luer Adapters and fittings from the existing Tube and remove the Tube from the Tube Adapter.
6. Install a new Tube by running the Tube through the Tube Support Assembly and installing the tubing over the Barb-to-Luer Adapter.
7. Tighten the Tube Fastener Screw and insert the Tube Support Assembly into the Valve Body.
8. Insert the Needle Tip.
9. Reinstall the Atomizing Cap to the desired depth/location and fix in place by tightening the Hex Screw.

Mounting

NOTE: *If the dispense valve is to be mounted in an area that limits access to the valve, it is recommended that the set-up operation be done prior to mounting. Access to various surfaces of the valve is necessary for periodic adjustment (see Specifications).*

Secure the 455 Valve to your Mount using the two 6-32 Tapped Holes located on the Valve Body. For easy adaptation, two holes are provided on either side of the Valve Body.

System Interconnect

Once the dispense valve is secured to its mounting surface, connect the 1/4" Air Line to the fitting on the Air-In Port located on the side of the Valve (Figure 5). This fitting has a #10-32 thread and can be relocated to the top of the Valve Body by removing the #10-32 Plug, and replacing it with the Push-In Air Fitting. Place the removed Plug into the tapped hole left by removing the Push-In Fitting from its original location.

Connect your Air Supply (60-120 psi) to the Normally Closed Outlet on your Valve Controller or 3-Way Solenoid Valve (a Valve Controller or a 3-Way Solenoid Valve must be used to operate the Model 455 Valve (CV of 0.1 or greater)).

Figure 5.
Air-In Port

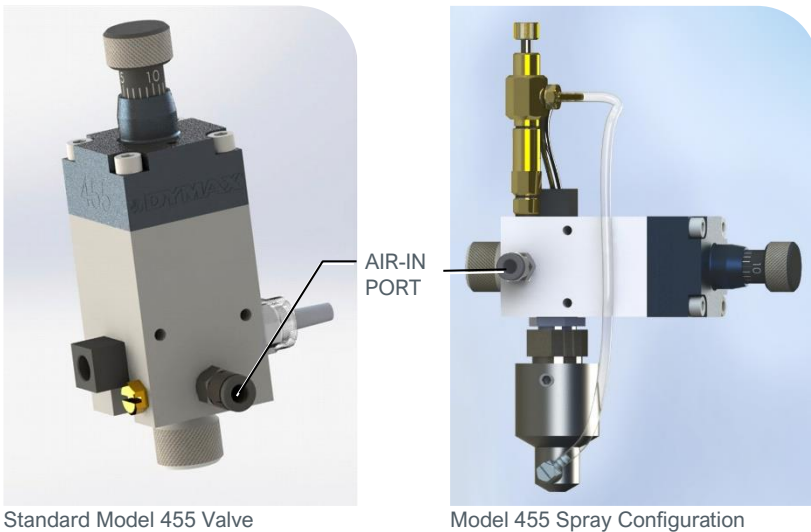

Valve Setting Adjustments

Adjusting Material Flow

NOTE: Failing to properly seat the tube support or adjust the valve piston pinch may result in premature tube failure and shot size accuracy.

When operating more than one valve, adjust each valve individually. Other pinch tube materials and needle bore sizes are available.

Figure 6.
Model 455 Flow Adjustment Procedure Components

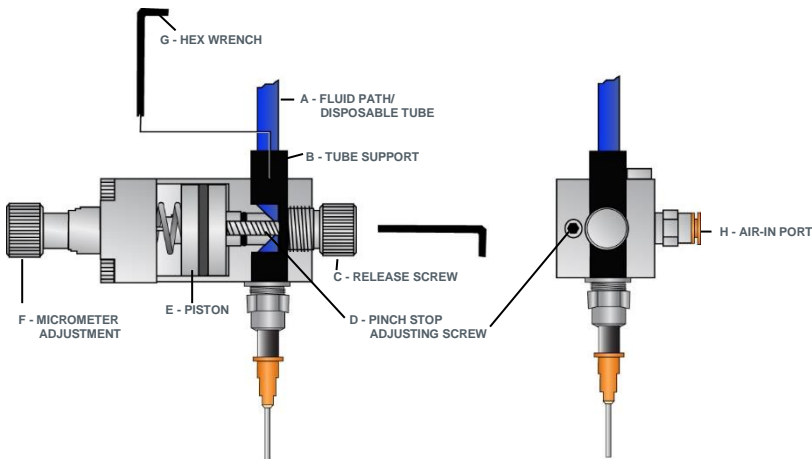

The Micrometer Adjustment controls the amount the Piston travels away from the Tube, thereby providing flow control. It is very important that the Tube Support (Figure 6, B) be firmly seated in the valve and secured tightly with the Release Screw. If it is not seated, tighten the Release Screw clockwise against the Tube Support until it is firmly seated. If the Release Screw appears to bind, remove it and lightly grease its threads.

NOTE: Securing the Tube Support Nut is easier if the valve is actuated during the tightening procedure.

To set the Piston (Figure 6, E) for the proper pinch of the fluid path (amount of closing), gradually pressurize the Material Reservoir and adjust the valve-piston pinch using the following steps:

1. Set the Reservoir's pressure to 5 psi.

NOTE: If the Pinch Stop Screw (Figure 6, D) prevents the Piston (Figure 6, E) from closing the Tubing (Figure 6, A), flow will begin as soon as the Material Reservoir is pressurized. If this happens, skip to step 6.

2. Initiate dispense (signal or actuate the solenoid valve). If there is no flow, increase the Material Reservoir's pressure until flow begins.
3. Stop dispense (remove signal from the solenoid valve).
 - a) If an increase of flow is needed: With the hex wrench provided, turn the Pinch Stop Screw (Figure 6, D) clockwise (Piston moves away from the Tube) until drops of liquid form at the Nozzle Tip. This screw pushes the Piston (Figure 6, E) and the pinch off the Tube (Figure 6, A).
 - b) If a decrease of flow is needed: Turn the Pinch Adjusting Screw counterclockwise (the Piston will move toward the Tube until the Tube is sufficiently closed. This stops the flow, but does not over-pinch the Tube). Usually an additional 15 degrees more than the zero-flow will provide a correct setting.
4. After adjusting the Pinch Stop Screw (Figure 6, D), turn the Micrometer Adjustment (Figure 5, F) in toward the valve until you feel resistance (closed position). Do not tighten it anymore once you feel resistance.

NOTE: You may cut the tubing if you tighten the Micrometer Adjustment Screw too much. The resistance you feel is the Micrometer Shaft pressing against the Piston.

5. To set the proper piston stop with the Micrometer Adjustment (amount of opening), back off the closed position as described above.

NOTE: One full turn of the Micrometer Adjustment (Figure 6, F) equals 0.025" of travel.

For small shot sizes (0.1 cc or less), back off a 1/2 turn.

For large shot sizes (1 cc or greater), back off one or two full turns (if using polyethylene tubing with 0.12" ID, back off three full turns).

These guidelines assume low viscosity fluid and 0.09" ID Teflon®, however the general instructions apply for any tubing.

Operating the Dispensing Valve

Figure 7.
Stages of Valve Operation

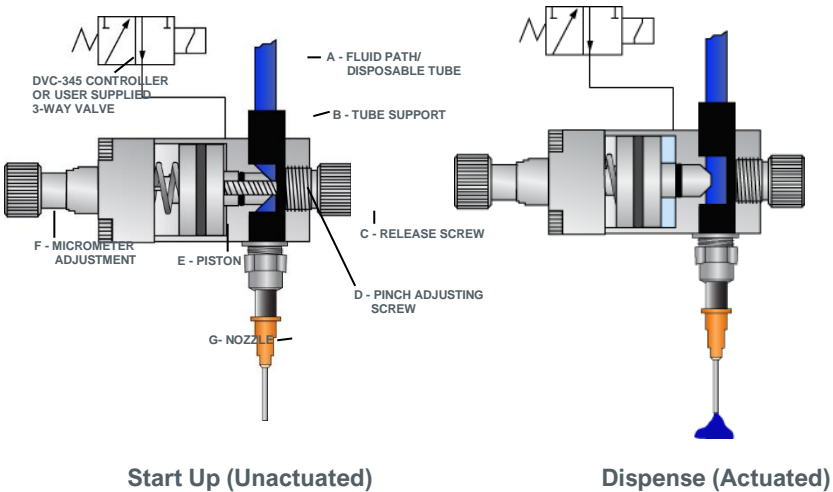

Start Up

When actuated from a DVC-345 Valve Controller or user-supplied, normally closed 3-Way Valve, the pinching surface of the Spring-Loaded Piston (Figure 7, E) prevents flow by collapsing the Fluid Path. The Pinch Adjusting Screw (Figure 7, D) limits stress on the Fluid Path (Figure 6, A) and provides a fixed start position for the Piston (Figure 7, E). This control greatly extends the life of the tubing and ensures shot-to-shot repeatability.

Dispense

When the Controller or user-supplied 3-Way Valve is on, air moves the Piston (Figure 7, E) back to the Adjustable Micrometer Stop (Figure 7, F). This controls the amount the Fluid Path (Figure 7, A) opens, which in turn controls the flow rate of the fluid. This action combined with the nozzle size (if a nozzle is used) and the time the 455 Valve is open, governs the amount of fluid that is dispensed.

Shot Size

There are four requirements for producing a shot size with a time/pressure dispensing system:

- The period and accuracy of the time the valve is "opened"
- Repeatability of the pressure on the material in the reservoir
- Repeatability of the pressure on the 455 valve
- Opening allowed for flow

The combination of these factors can be manipulated to produce the desired volume of dispensed material. The first three elements are controlled by the pressure regulation system and repeatability of the timing system. The fourth element, "opening allowed for flow", is controlled by the amount of closing and opening pinch on the dispense tube and the size of the dispense tip orifice. The pinch adjustments are particularly critical for precise repeatability.

Micro-Spray Nozzle Performance

The Model 455 spray attachment boasts even coating and excellent edge definition. Figure 8 is a general guideline for determining setup and area of spray coverage needed.

Proper spray volume is achieved by adjusting five (5) parameters: the tip gauge, the fluid pressure, the Valve Flow Control, the Atomizing Air Flow Control (controls atomizing air relative to the amount of fluid), and the amount of time the valve is on. Proper adjustment of these items yields a precisely controlled repetitive spray pattern and dispensed volume.

Figure 8.
Model 455 Micro-Spray Valve Set Up

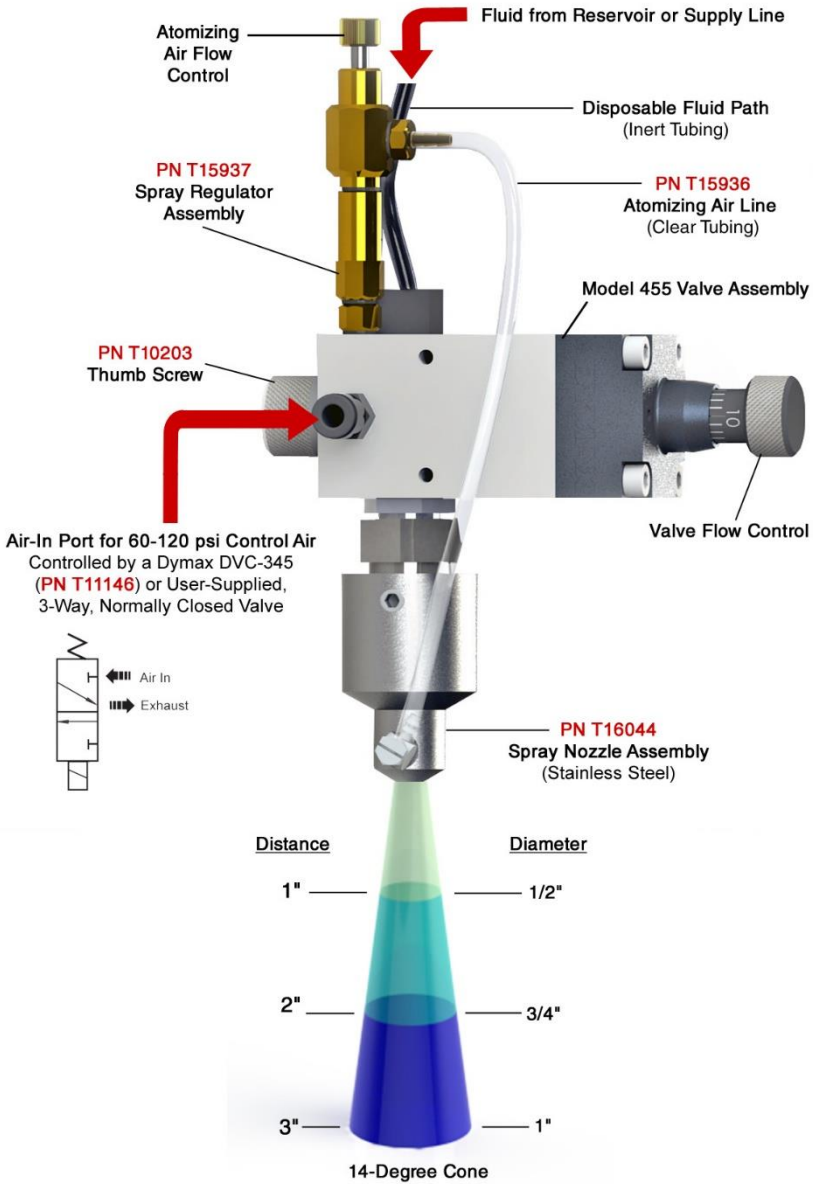

Maintenance

Seal Replacement

Although it is extremely rare, it may be necessary to change the Seals in the 455 Valve. To change the Seals, use Figure 9 and follow the instructions.

1. Remove the Tube Support (Figure 9, E) from the Valve Body (Figure 7, D) by loosening the Release Screw (Figure 9, K).
2. Remove the four 6-32 SOC HD Cap Screws (Figure 9, A) located on the end of the Valve End Cap (Figure 9, F).

CAUTION! End Cap (Figure 9, F) is under the force of the Compression Spring (Figure 9, G). Use care when removing.

3. Remove the Compression Spring (Figure 9, G) from the Valve Body.
4. Remove the Piston (Figure 9, H) from Valve Body.
5. Remove the worn Seals (Figure 9, C & I) and replace. A small amount of silicone grease should be applied to extend seal life.
6. Replace the Piston (Figure 9, H) and the Compression Spring (Figure 9, G).
7. Align the Piston Anti-Rotation Pin (Figure 9, B) with the corresponding hole located on the Valve End Cap (Figure 9, F).
8. Replace the Screws (Figure 7, A) thru the Valve End Cap (Figure 9, F) into Valve Body (Figure 9, D) and tighten.

Figure 9. Seal Replacement Diagram

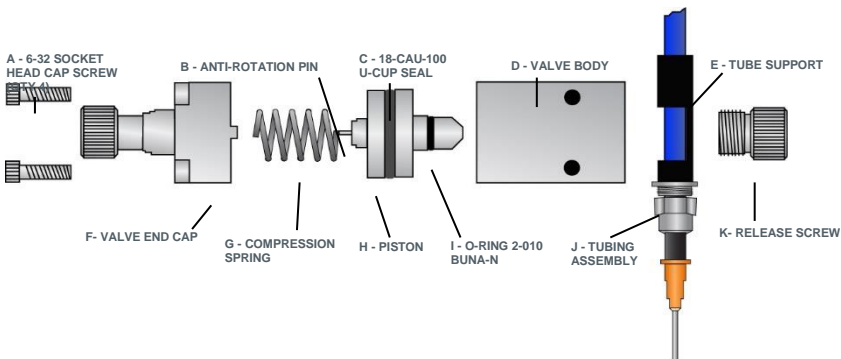

Troubleshooting

Table 1.

Troubleshooting Chart for Model 455 Dispensing Valve













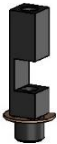
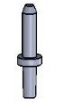









Problem	Possible Cause	Corrective Action
Valve does not dispense anything	Supply air pressure is too low	Increase the supply air pressure to a minimum of 60 psi.
	Material is cured in the tip	Disassemble and clean tip
Air bubbles in fluid	Valve not properly purged	Point valve up and cycle until air bubbles are removed
	Problem with material reservoir and fluid delivery system	Diagnose and repair
Material leaks from valve tip	Valve flow is not adjusted correctly	Follow flow adjustment procedures
	Air bubble trapped in fluid body or in dispense needle	Flip valve upside down and cycle until air bubbles are removed
Dispense rate too fast	Valve flow is not adjusted correctly	Tighten flow adjustment knob
	Fluid pressure set too high	Decrease fluid pressure
	Dispense tip gauge too large	Replace dispense tip with smaller size tip
Dispense rate too slow	Valve flow is not adjusted correctly	Loosen flow adjustment knob
	Fluid pressure set too low	Increase fluid pressure
	Dispense tip gauge too small	Replace dispense tip with larger size tip

Spare Parts and Accessories

Options/Accessories

Item	Part Number
Air Regulators	
Filter Regulator	T16307
High-Precision Regulator	T16629
Controllers	
DVC-345 Digital Valve Controller	T11146
Stands	
Lab Stand – 24" [60.96 cm]	T15279
8" [20.32 cm] Mounting Rod Kit- 455valve	T15449
Fluid Path Assembly Replacement Kits	
Teflon® Tubing Assembly, 0.066" [1.68 mm]	T17409
Teflon® Tubing Assembly, 0.095" [2.41 mm]	T17554
Polyethylene Tubing Assembly, 0.125" [3.17 mm]	T17557
Spray Conversion Kits	
Teflon® Spray Conversion Kit, 0.066" [1.68 mm]	T18489
Teflon® Spray Conversion Kit, 0.095" [2.41 mm]	T18490
Polyethylene Spray Conversion Kit, 0.125" [3.17 mm]	T18491
Rebuild Kit	
Seal Rebuild Kit	T16781

Replacement Tubing Assemblies/ Conversion Kits

0.125" ID Polyethylene (PN T17557)	0.095" ID Teflon® (PN T17554)	0.066" ID Teflon® (PN T17409)	Spray Valve Conversion Kits 0.066" ID (PN T18489) 0.095" ID (PN T18490) 0.125" ID (PN T18491)
<p>T18386 1/4 NPT - 1/8 BARB, STRAIGHT</p>  <p>T18368 TUBING, FLEX, BLK 0.125" ID</p>  <p>T15776 TUBE SUPPORT, 0.125" ID x 0.187" OD</p>  <p>T14144 RETAINING RING, EXT, 0.375" SHAFT</p>  <p>T10201 TUBE-TO- LUER ADAPTER, URETHANE</p>  <p>T17551 NUT, CHROME, 3/8-24</p> 	<p>T15053 0.25" ADAPTER BUSHING</p>  <p>T15052 (x2) TUBING INSERT, 0.095" ID</p>  <p>T15051 TUBING PASS- THRU NUT, 0.130" ID</p>  <p>T18376 TEFLON TUBING, 0.095" ID</p>  <p>T10198 TUBE</p>  <p>SUPPORT, 0.095" ID x 0.125" OD</p>  <p>T14144 RETAINING RING, EXT, 0.375" SHAFT</p>  <p>T15220 TUBE-TO- LUER ADAPTER, TEFLON</p>  <p>T17551 NUT, CHROME, 3/8-24</p> 	<p>T15053 0.25" ADAPTER BUSHING</p>  <p>T15050 (x2) TUBING INSERT, 0.066" ID</p>  <p>T15048 TUBING NUT, 0.066"</p>  <p>T16028 TEFLON TUBING, 0.066" ID</p>  <p>T10199 TUBE SUPPORT, 0.066" OD</p>  <p>T14144 RETAINING RING, EXT, 0.375" SHAFT</p>  <p>T15220 TUBE-TO- LUER ADAPTER, TEFLON</p>  <p>T17551 NUT, CHROME, 3/8-24</p> 	 <p>Diagram showing the assembly of the spray valve conversion kits, including the spray valve body, tubing, and various fittings.</p>

Specifications

Property	Specification
Dispensing Valve Part Numbers	T16029 Model 455 valve with 0.066" Teflon® tubing T17552 Model 455 valve with 0.095" Teflon® tubing T17555 Model 455 valve with 0.125" Polyethylene tubing
Spray Valve Part Numbers	T18002 Model 455 spray valve with 0.066" Teflon® tubing T18000 Model 455 spray valve with 0.095" Teflon® tubing T18004 Model 455 spray valve with 0.125" Polyethylene tubing
Valve Type	Pinch with disposable fluid path
Construction Material	Anodized Aluminum
Operating Air Pressure	60-120 psi [4.14 – 8.27 bar]
Maximum Inlet Fluid Pressure	Tubing dependent; 100 psi [6.89 bar](typical)
Maximum Operating Temperature	350°F [177°C] with Teflon® tubing
Typical Flow Rates with Water	0.125" [3.17 mm] ID - 30 mL/second
	0.095" [2.41 mm] ID - 15 mL/second
Maximum Tubing Size	0.25" [6.35 mm] OD
Activation	Valve controller or 3-way solenoid valve
Dimensions (W x D x H)	3.75" x 1.125" x 1.125" [9.53 cm x 2.86 cm x 2.86 cm]
Weight	5.5 oz [146 g]
Unit Warranty	1 year from purchase date



Figure 10.
Model 455 Dispensing Valve Dimensional Drawing

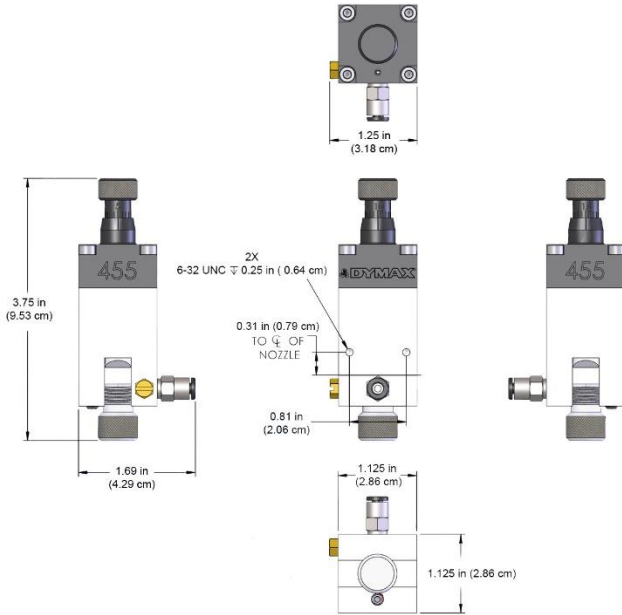
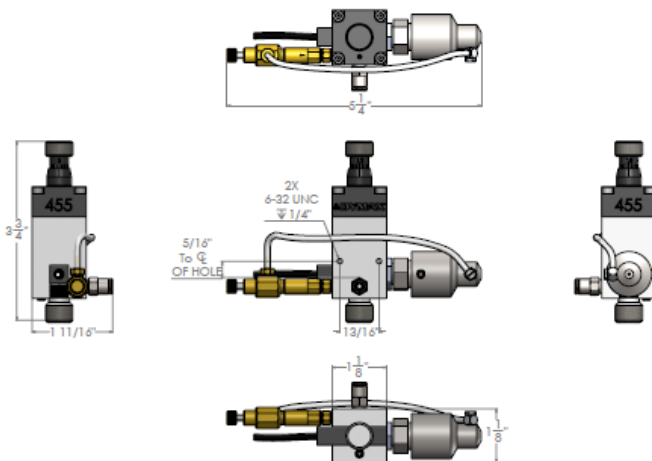

Figure 11.
Model 455 Spray Valve Dimensional Drawing



Warranty

From date of purchase, Dymax Corporation offers a one-year warranty against defects in material and workmanship on all system components with proof of purchase and purchase date. Unauthorized repair, modification, or improper use of equipment may void your warranty benefits. The use of aftermarket replacement parts not supplied or approved by Dymax Corporation will void any effective warranties and may result in damage to the equipment.

IMPORTANT NOTE: DYMAX CORPORATION RESERVES THE RIGHT TO INVALIDATE ANY WARRANTIES, EXPRESSED OR IMPLIED, DUE TO ANY REPAIRS PERFORMED OR ATTEMPTED ON DYMAX EQUIPMENT WITHOUT WRITTEN AUTHORIZATION FROM DYMAX. THOSE CORRECTIVE ACTIONS LISTED ABOVE ARE LIMITED TO THIS AUTHORIZATION.

Index

Assembly and Setup, 8
Contact Information, 4
Disposable Fluid Path, 7
Features and Benefits, 7
Help, 4
Maintenance, 17
 Seal Replacement, 17
Mounting, 10
Operation, 14
 Dispense, 14
 Start Up, 14
Optional Equipment, 19
Over-Pinch Adjustment, 7
Parts Included, 8
Product Overview, 5

Replacement Tubing Assemblies, 20
Safety, 4
 Preventing Injection Injury, 5
 Using Safe Operating Pressures, 5
Spare Parts and Accessories, 19
Specifications, 21
System Interconnect, 11
Technical Description of 455 Valve, 5
Troubleshooting, 18
Tube Installation, 9, 10
Unpacking, 8
Valve Setting Adjustments, 11
 Material Flow, 11
Warranty, 23



Americas

USA | +1.860.482.1010 | info@dymax.com

Europe

Germany | +49 611.962.7900 | info_de@dymax.com
Ireland | +353 21.237.3016 | info_ie@dymax.com

Asia

Singapore | +65.67522887 | info_ap@dymax.com
Shanghai | +86.21.37285759 | dymaxasia@dymax.com
Shenzhen | +86.755.83485759 | dymaxasia@dymax.com
Hong Kong | +852.2460.7038 | dymaxasia@dymax.com
Korea | +82.31.608.3434 | info_kr@dymax.com

© 2012-2021 Dymax Corporation. All rights reserved. All trademarks in this guide, except where noted, are the property of, or used under license by Dymax Corporation, U.S.A. Teflon® is a registered trademark of DuPont.

The data contained in this bulletin is of a general nature and is based on laboratory test conditions. Dymax Europe GmbH does not warrant the data contained in this bulletin. Any warranty applicable to products, its application and use is strictly limited to that contained in Dymax Europe GmbH's General Terms and Conditions of Sale published on our website. Dymax Europe GmbH does not assume any responsibility for test or performance results obtained by users. It is the user's responsibility to determine the suitability for the product application and purposes and the suitability for use in the user's intended manufacturing apparatus and methods. The user should adopt such precautions and use guidelines as may be reasonably advisable or necessary for the protection of property and persons. Nothing in this bulletin shall act as a representation that the product use or application will not infringe a patent owned by someone other than Dymax Corporation or act as a grant of license under any Dymax Corporation Patent. Dymax Europe GmbH recommends that each user adequately test its proposed use and application of the products before actual repetitive use, using the data contained in this bulletin as a general guide.

T16589 MAN030EU 10/23/2020